



Coupling modes

Véronique Beauvois, Ir.
2021-2022



General problem in EMC = a trilogy

Parameters

- Amplitude
- Spectrum
- ...

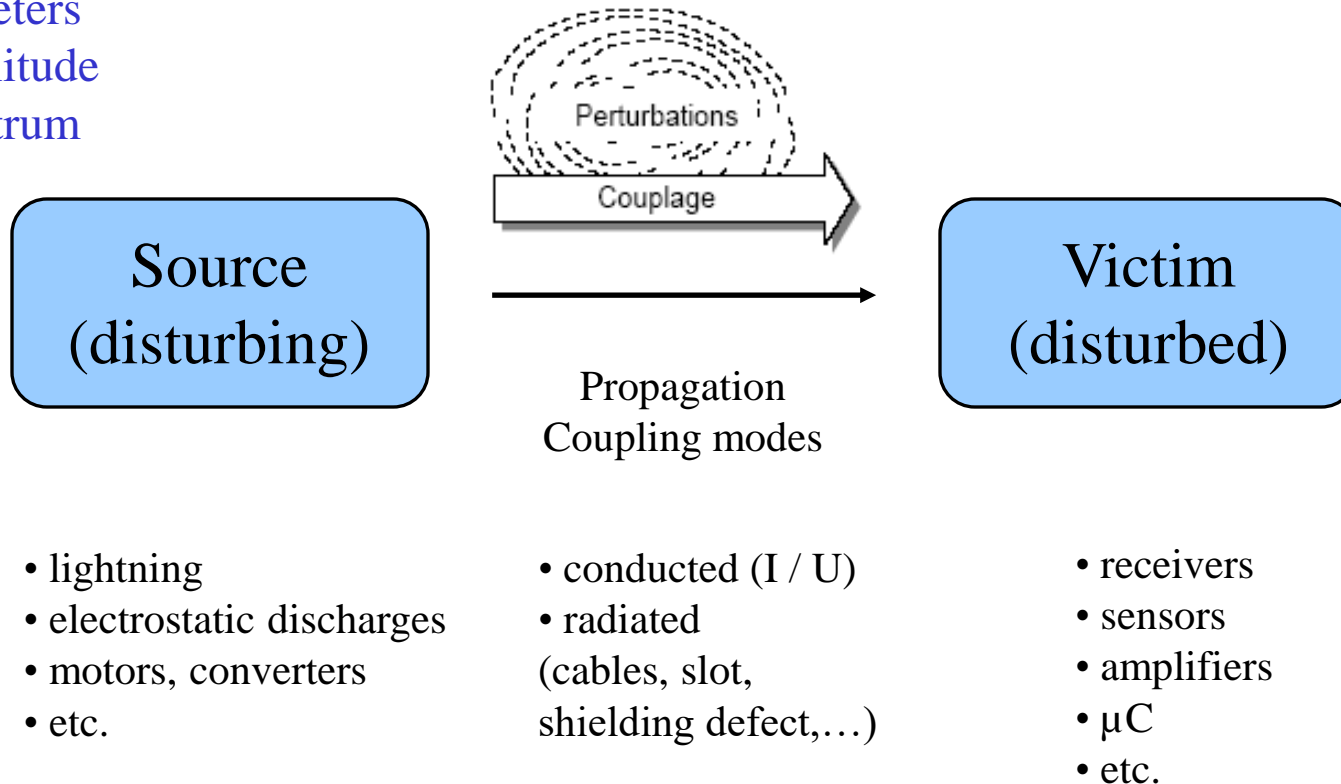



General solution in EMC = a trilogy

Source
(disturbing)



Victim
(disturbed)

Propagation
Coupling mode

↑
To act on the source
(not always possible)

↑
To reduce the efficiency
of the coupling mode
= frequently only solution

↑
To act on the victim
(increasing immunity –
reducing susceptibility)

or different combined solutions

Remark : reciprocity (improving emission frequently improving immunity)



1st step: to identify the disturbing elements

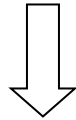

Protections

↻ for inter-system
↻ for **intra**-system

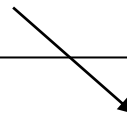

= source & victim
inside the same system

To identify the
disturbing elements,
the coupling paths,
...

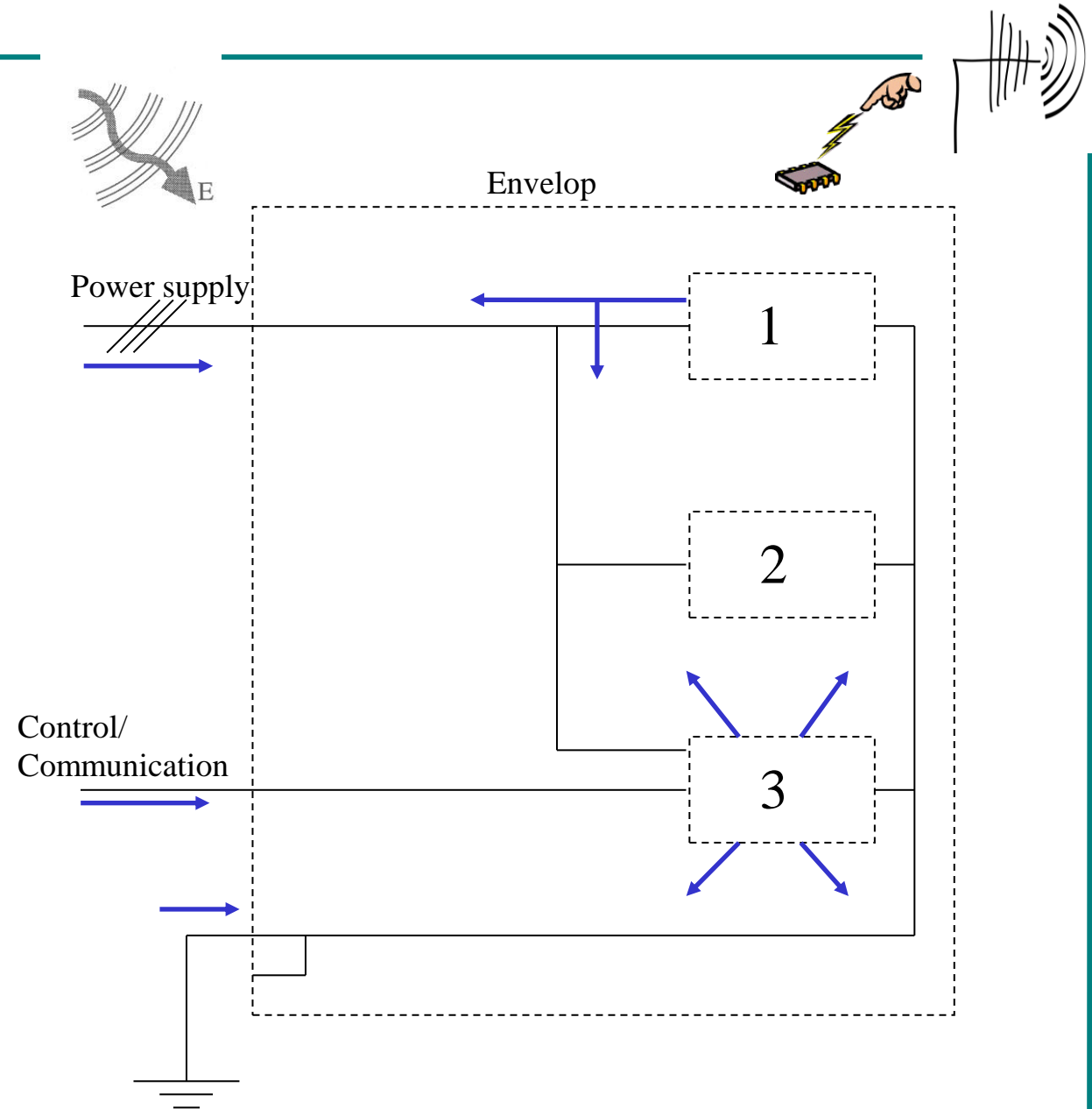

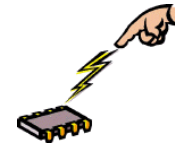
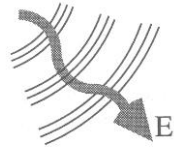

Envelop

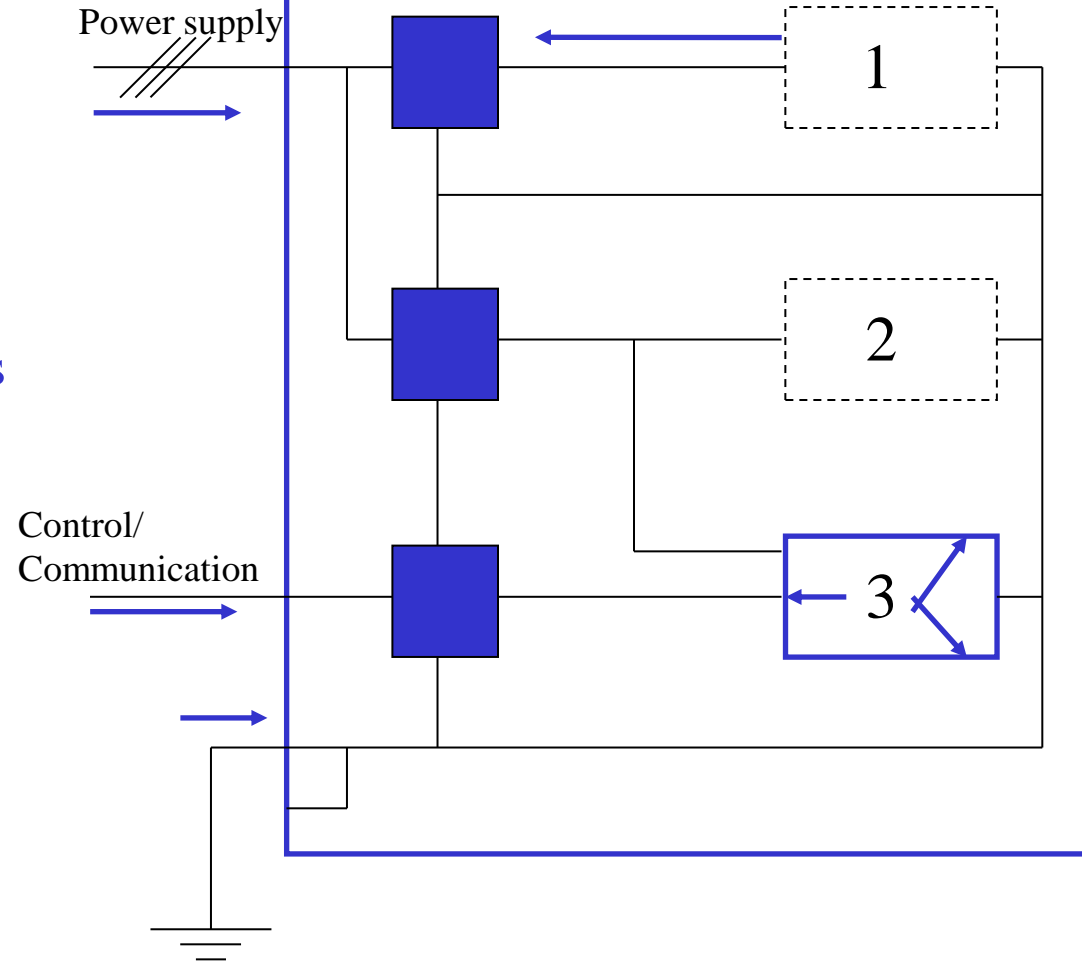

To change the design
To add components
to reduce some effects



 360° HF grounding

 Shielded cable

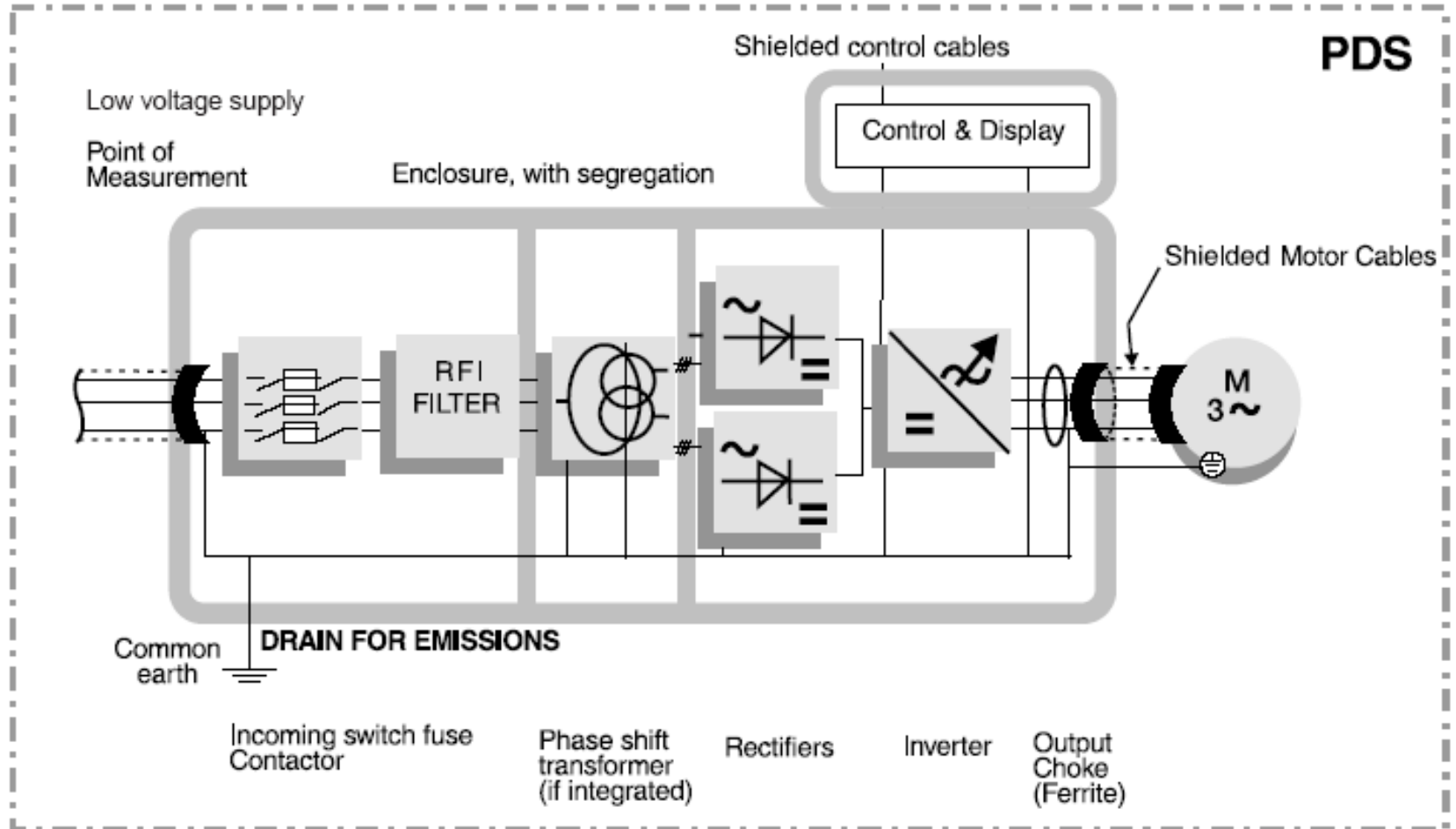



Coupling modes (1)

The coupling modes between source and victim could be classified according to:

- Common mode
- Differential mode

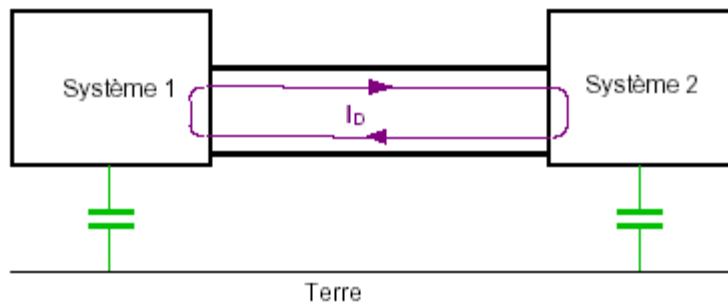

Differential mode (DM)

(or symmetrical) : current is in one conductor in one direction and in phase opposition in the second conductor (e.g. power supply, RS-485, CAN, USB).

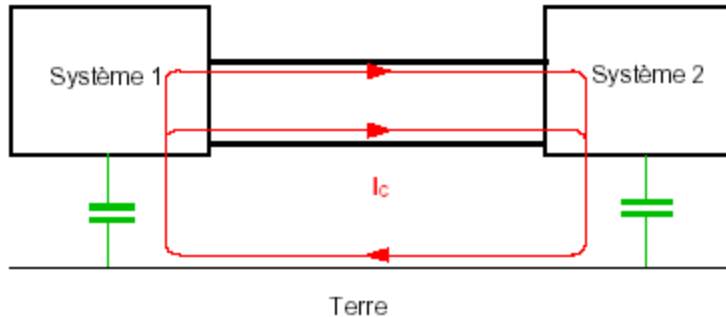

Common Mode (CM)
 (or asymmetrical or longitudinal) :
 current on both conductors in
 the same direction.

The EM disturbances are weakly coupled in DM as conductors are nearby. On the other hand, in CM, current could be induced by an external field.

> How to measure CM and DM?



Coupling modes (1)

How to measure CM and DM?
With a current clamp

CM

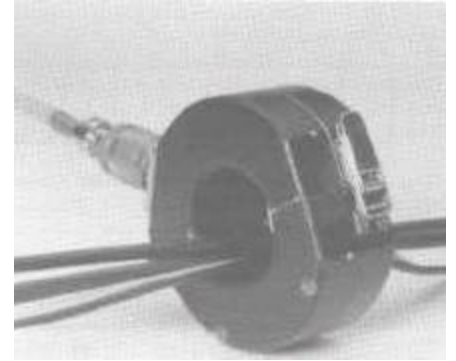
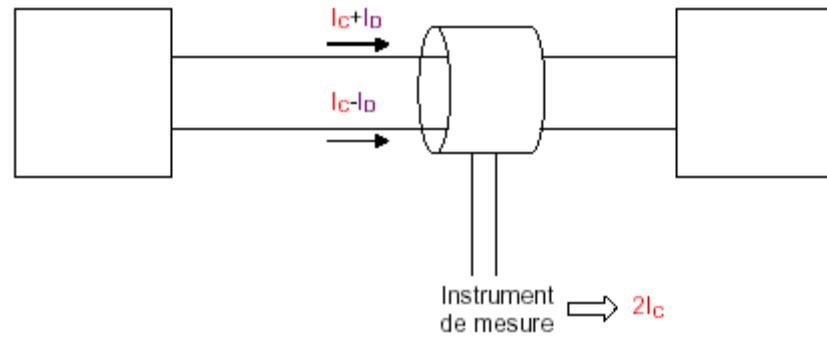

DM

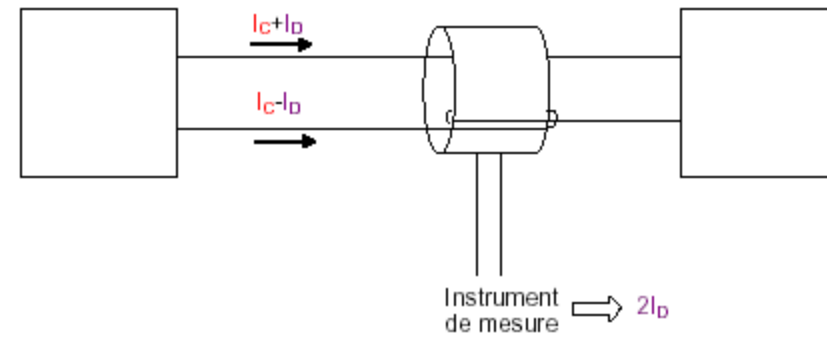



Coupling modes (1)

Conversion between **DM** and **CM**?

Related to the parasitic impedances of different values

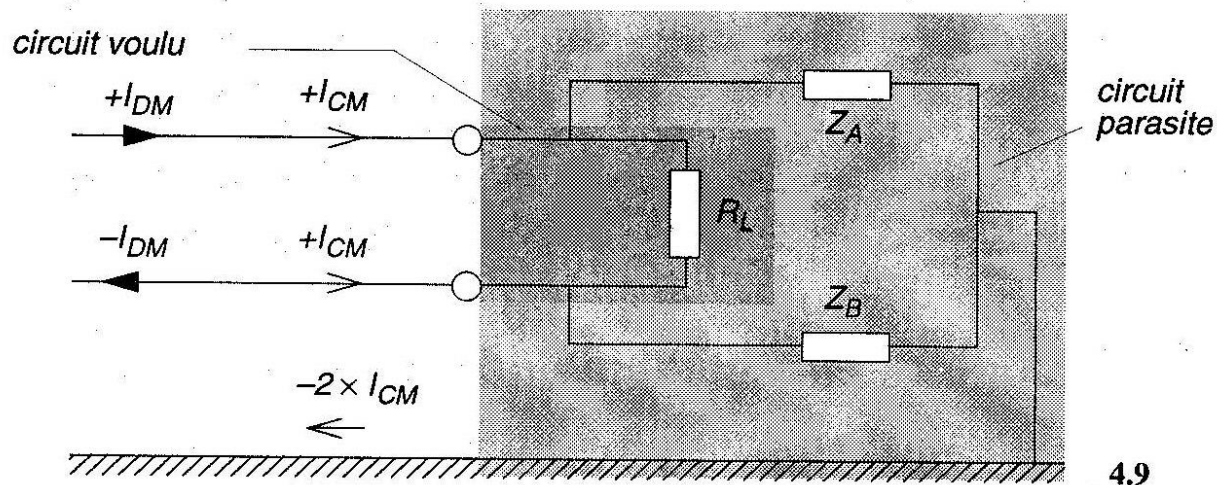

Origin? When 2 conductors have a different impedance regarding earth (e.g. parasitic capacitors)

If $Z_A = Z_B$, there is no voltage across R_L due to I_{CM}

If $Z_A \neq Z_B$, $V_{Load(CM)} = I_{CM} \cdot (Z_A - Z_B)$



Coupling modes (2)

A. Common impedance coupling (conducted coupling)
= common conductor

Considering a conductor AB, impedance $Z(f) (\neq 0)$:

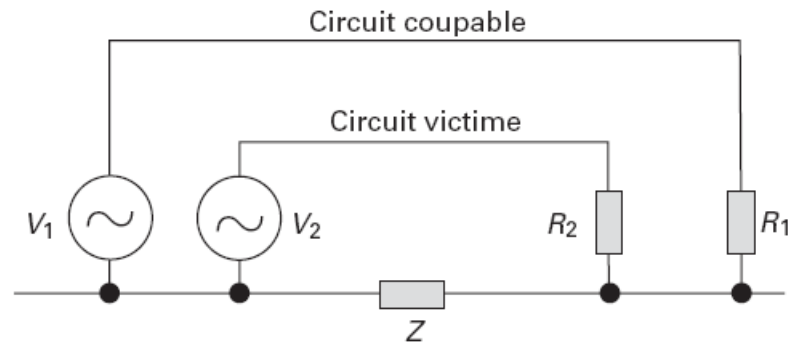
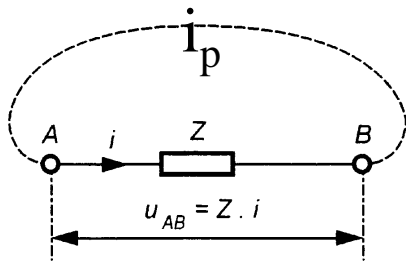

Z impédance commune aux deux circuits

Solutions:

- to decrease Z (coupling)
- to decrease i_p (source)

Coupling modes (2)



A. Common impedance coupling (conducted coupling) = common conductor

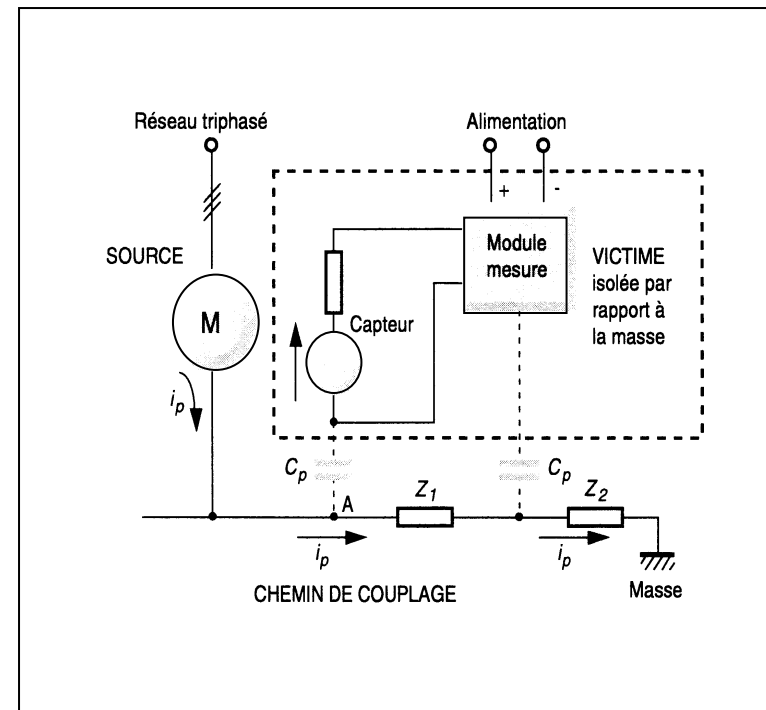
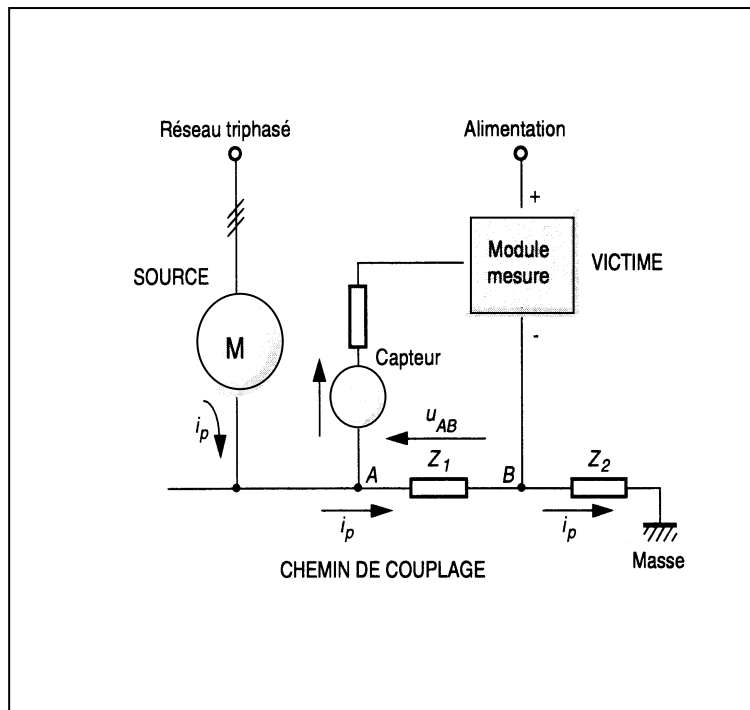



Coupling modes (2)

A. Common impedance coupling (conducted coupling) = common conductor

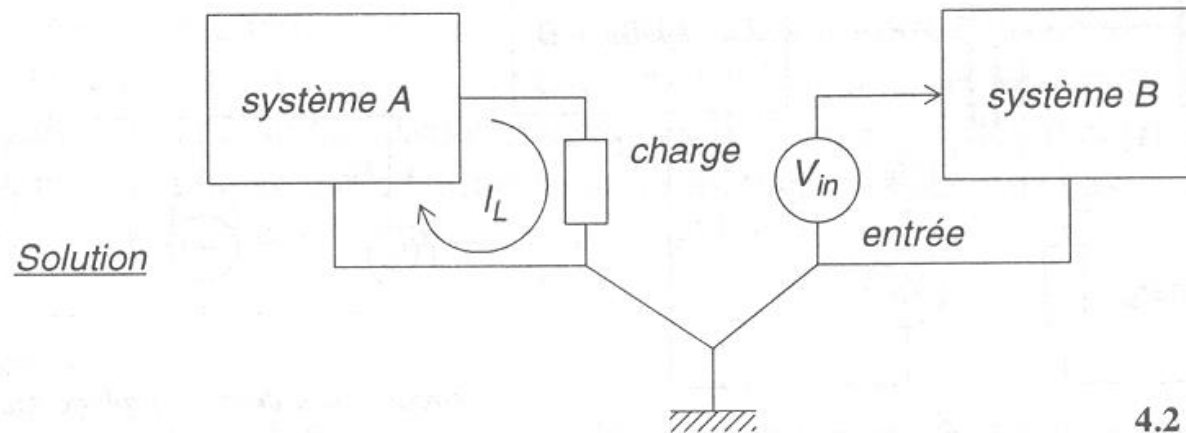
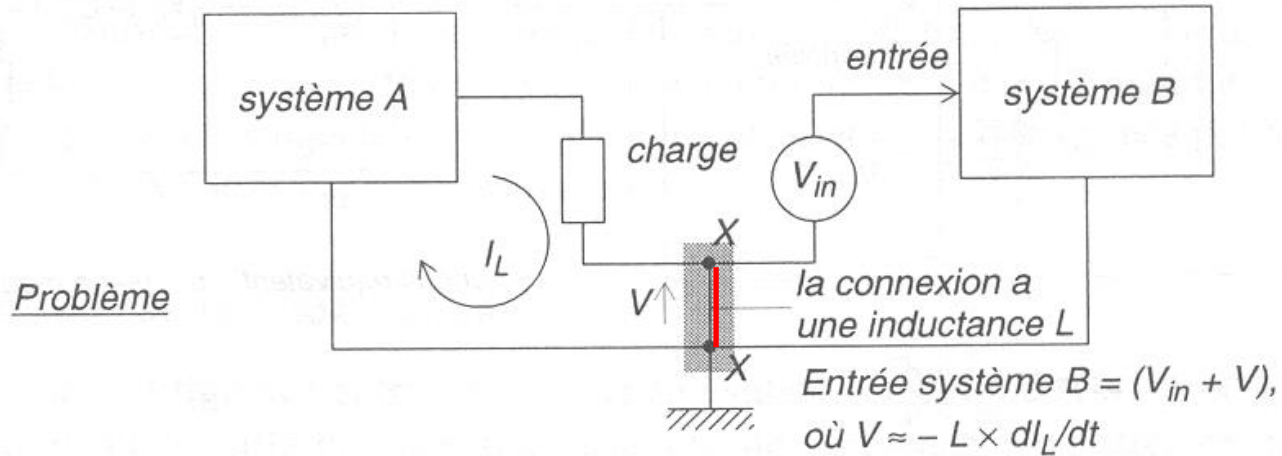

4.2



Coupling modes (2)

B. Inductive Coupling

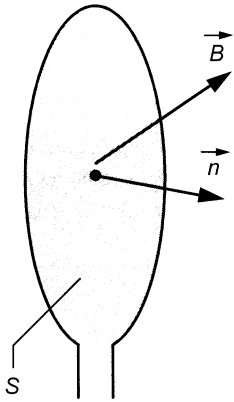

The circulation of a current in a conductor creates a magnetic field, which could couple with a nearby circuit, and induced a voltage.

Solutions:

- source: to decrease $d\mathbf{B}/dt$
- victim: to decrease S or modify orientation
(\underline{n} and \underline{B} perpendicular, $\mathbf{B} // \text{loop}$)
- coupling: to increase distance or add a magnetic screen



Coupling modes (2)

B. Inductive Coupling

External disturbance

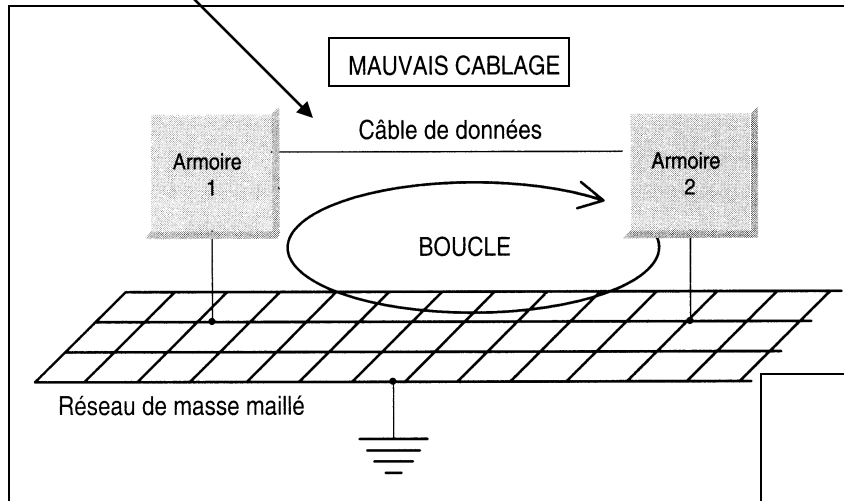

To reduce S loop

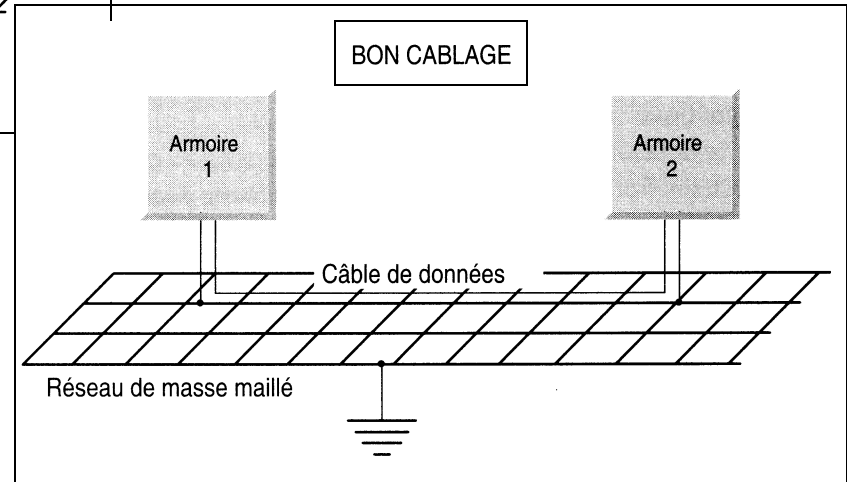
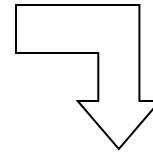



Coupling modes (2)

B. Inductive Coupling

Inductive diaphony

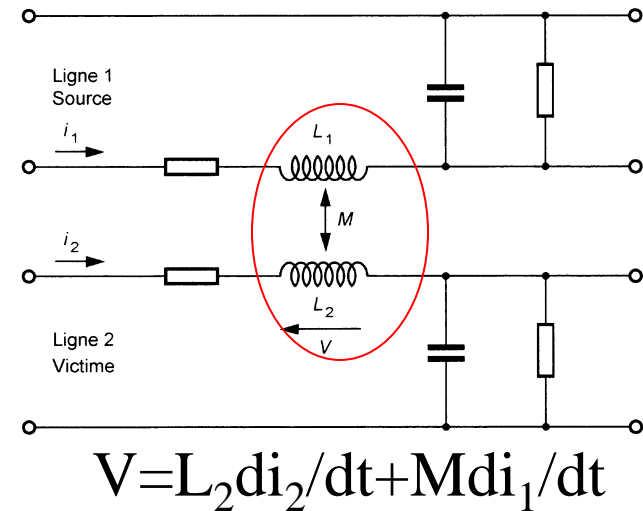
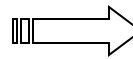
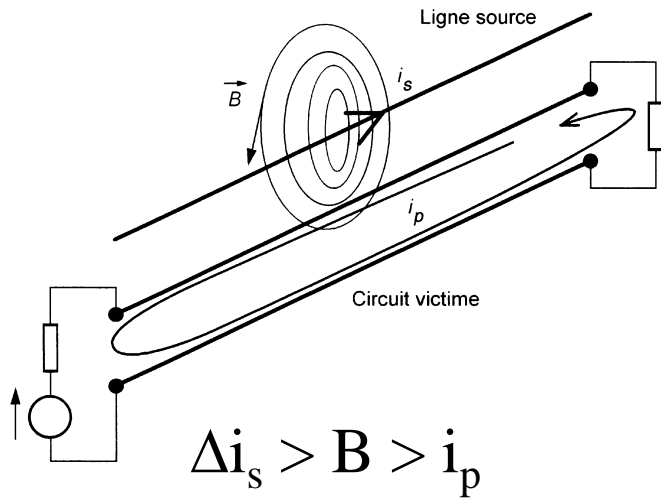
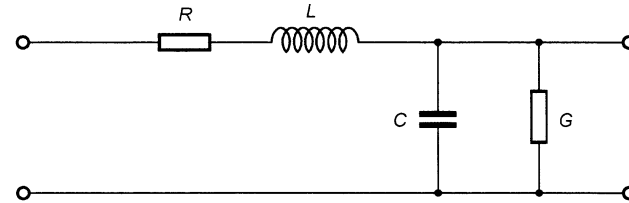



Coupling modes (2)

B. Inductive Coupling

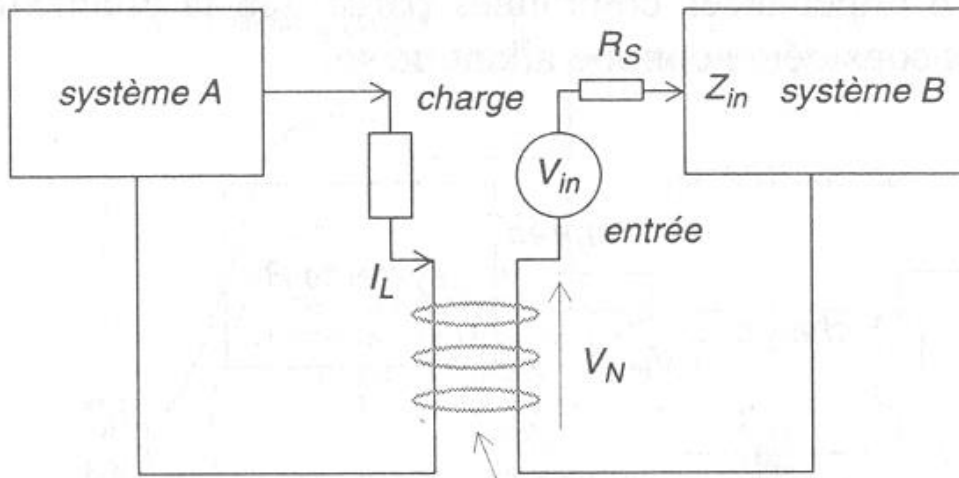

inductance mutuelle M

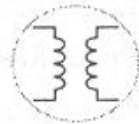

$$V_N = - M \times dI_L/dt$$

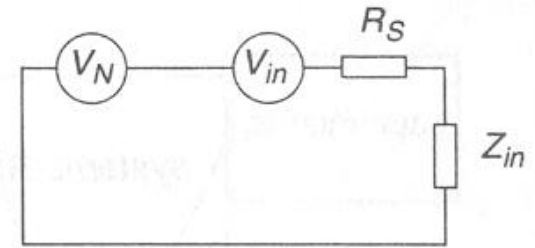

circuit équivalent – couplage magnétique

(a)



Coupling modes (2)

C. Capacitive Coupling

$dU/dt > E$ electric field could couple with a nearby conductor and generate a voltage

Solutions:

- source: to reduce dU/dt
- coupling: to increase distance

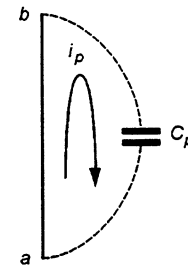
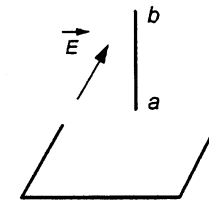



C. Capacitive Coupling

Capacitive diaphony

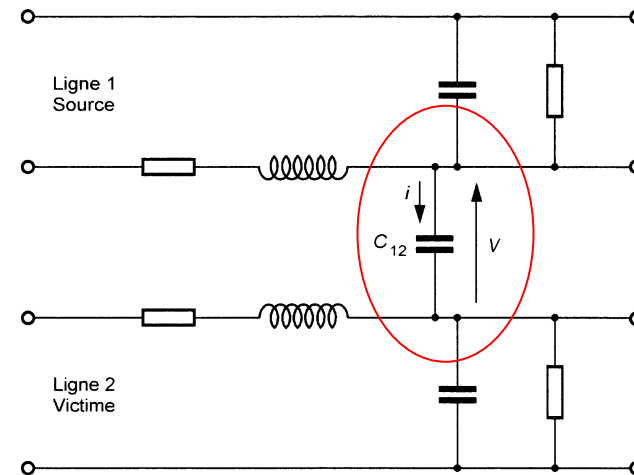
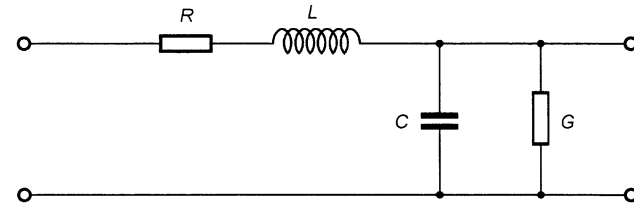



Coupling modes (2)

C. Capacitive Coupling

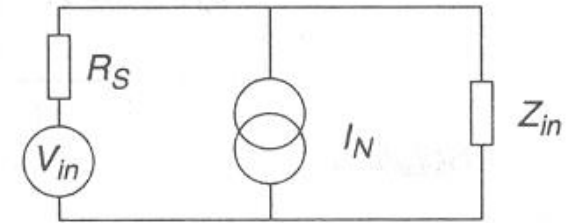
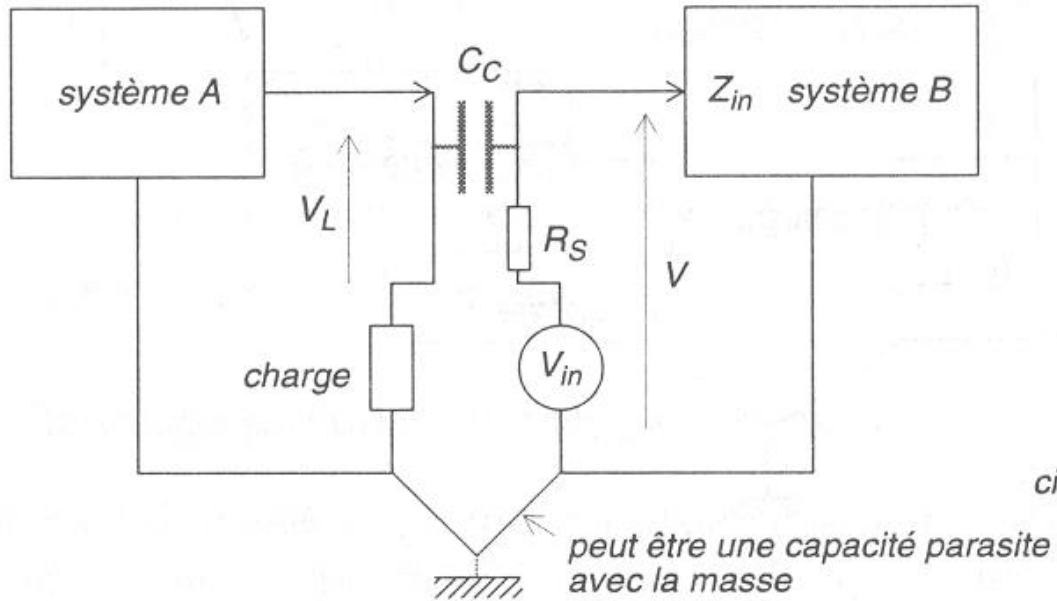

circuit équivalent – couplage électrique

(b) 4.3

$$V = C_C \times dV_L/dt \times (Z_{in} // R_S)$$

Impedance of victim circuit to ground



Coupling modes (2)

Input impedance?

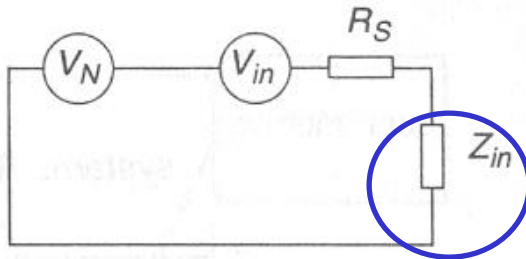

circuit équivalent – couplage magnétique

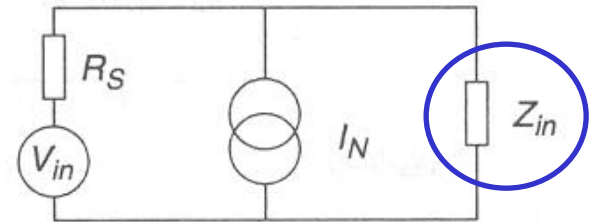

circuit équivalent – couplage électrique

Electric coupling *increases* with Z_{IN} growing
whereas magnetic coupling *decreases*.

For the same reason, magnetic coupling is related to circuits with low input impedance as electric coupling to high input impedance.



Coupling modes (2)

Relationship distance - M and C

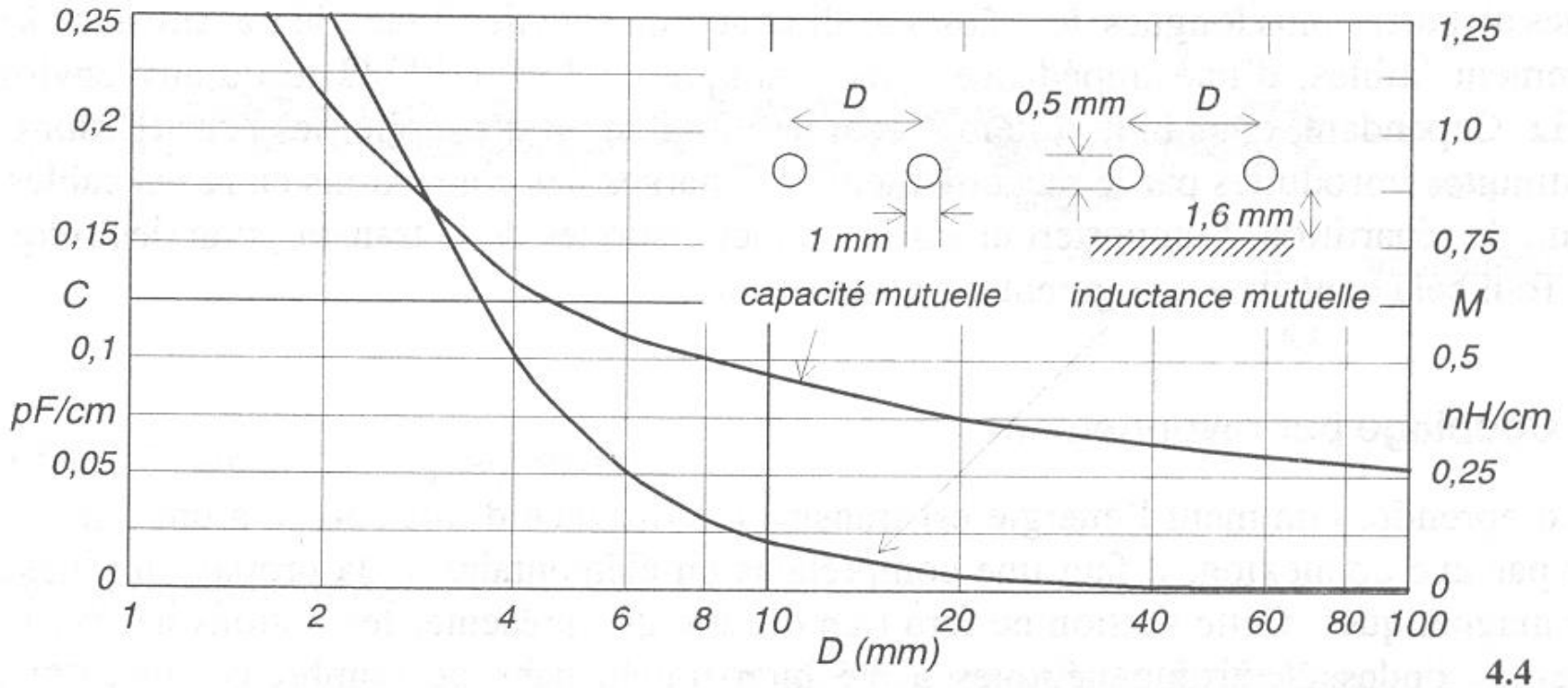



Coupling modes (2)

D. Radiated Coupling

- H-field (field to loop)
- E-field (field to conductor)



D. Radiated Coupling

1. Electromagnetic field of short electric dipole

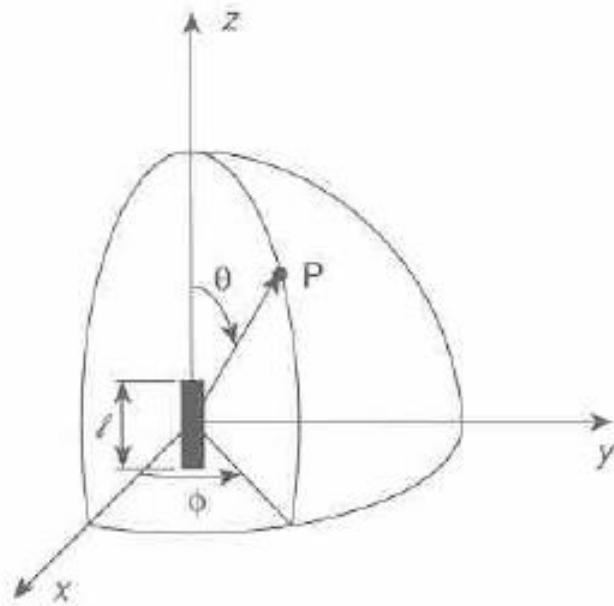

Conductor length l with a current I_0

$l \ll \ll \lambda$ of the field

So I_0 is constant on l



1. Electromagnetic field of short electric dipole

Electromagnetic fields (in spherical coordinates) is evaluated at an observation point P at a distance r from the origin:

$$E_r = \frac{Z_0 I_0 l \cos \theta}{2\pi r^2} \left(1 + \frac{1}{jkr} \right) \exp(-jkr)$$

$$E_\theta = \frac{jZ_0 k I_0 l \sin \theta}{4\pi r} \left(1 + \frac{1}{jkr} - \frac{1}{(kr)^2} \right) \exp(-jkr)$$

$$H_\phi = \frac{jk I_0 l \sin \theta}{4\pi r} \left(1 + \frac{1}{jkr} \right) \exp(-jkr)$$

où

$$k = 2\pi/\lambda = 2\pi f / c$$

$$Z_0 = \sqrt{\mu / \epsilon}$$



1. Electromagnetic field of short electric dipole

We have to consider 3 cases:

- $r \gg \lambda/(2\pi)$ or $kr \gg 1$

far-field

- $r \ll \lambda/(2\pi)$ or $kr \ll 1$

near-field

- $r \approx \lambda/(2\pi)$ or $kr \approx 1$

intermediate zone



1. Electromagnetic field of short electric dipole

Far-field

For $\theta=0^\circ$, no electromagnetic wave,
consider $\theta=90^\circ$ (maximum of radiation):

$$E_r = 0$$

$$E_\theta = \frac{jZ_o k I_o l}{4\pi r} \exp(-jkr)$$

$$H_\phi = \frac{jk I_o l}{4\pi r} \exp(-jkr)$$

Characteristic
Impedance

$$Z_w = \left| \frac{E_\theta}{H_\phi} \right| = Z_o = \sqrt{\frac{\mu}{\epsilon}}$$

Dans le vide,

$$Z_o = 120\pi \cong 377 \Omega$$



1. Electromagnetic field of short electric dipole

Near-field

$$E_r = \frac{Z_0 I_0 l \cos \theta}{2\pi j k r^3} \exp(-jkr)$$

$$E_\theta = -\frac{jZ_0 I_0 l \sin \theta}{4\pi k r^3} \exp(-jkr)$$

$$H_\phi = \frac{1}{4\pi} \frac{I_0 l \sin \theta}{r^2} \exp(-jkr)$$

Characteristic Impedance

$$Z_w = \left| \frac{E_\theta}{H_\phi} \right| = \frac{Z_0}{kr}$$



1. Electromagnetic field of short electric dipole

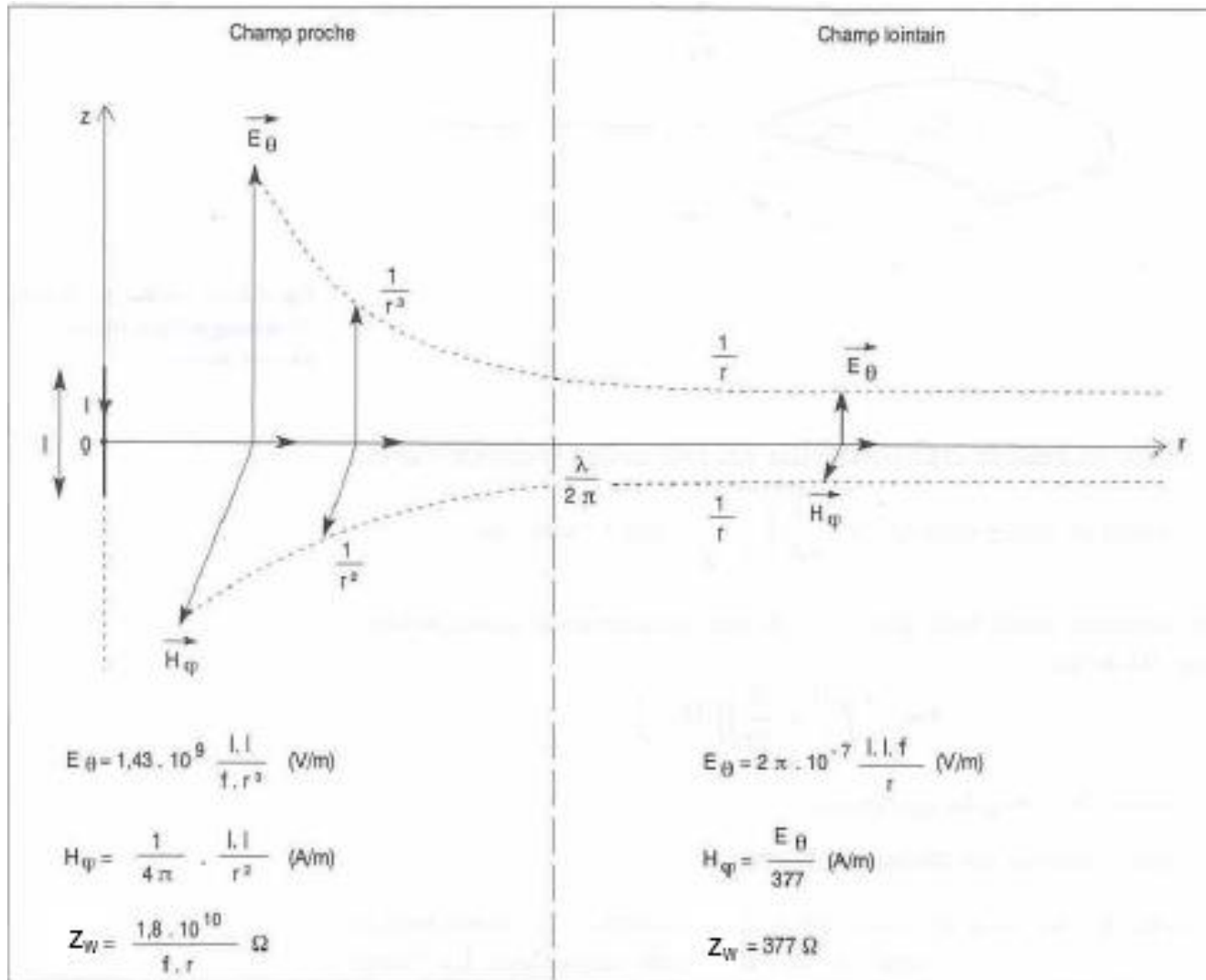



D. Radiated Coupling

2. Electromagnetic field of magnetic dipole

Consider a loop with I_0

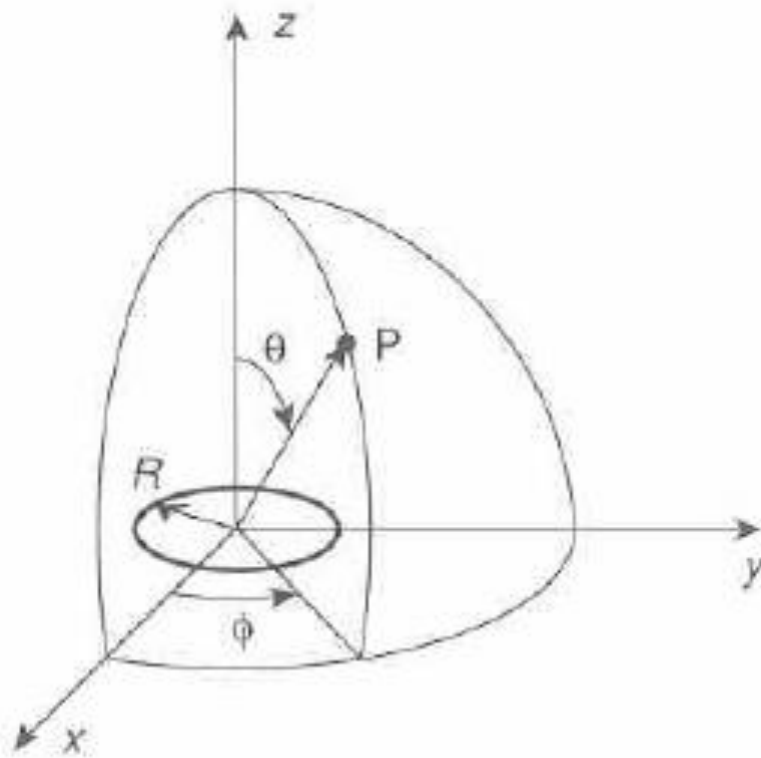



2. Electromagnetic field of magnetic dipole

Electromagnetic fields (in spherical coordinates):

$$H_r = \frac{jk \pi R^2 I_o \cos \theta}{2\pi r^2} \left(1 + \frac{1}{jkr} \right) \exp(-jkr)$$

$$H_\theta = \frac{-k^2 \pi R^2 I_o \sin \theta}{4\pi r} \left(1 + \frac{1}{jkr} - \frac{1}{(kr)^2} \right) \exp(-jkr)$$

$$E_\phi = \frac{Z_o k^2 \pi R^2 I_o \sin \theta}{4\pi r} \left(1 + \frac{1}{jkr} \right) \exp(-jkr)$$

2. Electromagnetic field of magnetic dipole



Far-field ($r \gg \lambda/(2\pi)$)

For $\theta=90^\circ$:

$$H_r = 0$$

$$H_\theta = \frac{-k^2 \pi R^2 I_0}{4\pi r} \exp(-jkr)$$

$$E_\phi = \frac{Z_0 k^2 \pi R^2 I_0}{4\pi r} \exp(-jkr)$$

Characteristic
Impedance

$$Z_w = \left| \frac{E_\phi}{H_\theta} \right| = Z_0 = \sqrt{\frac{\mu}{\epsilon}}$$

2. Electromagnetic field of magnetic dipole



Near-field ($r \ll \lambda/(2\pi)$)

$$H_r = \frac{1}{2\pi} \frac{\pi R^2 I_o \cos \theta}{r^3} \exp(-jkr)$$

$$H_\theta = \frac{1}{4\pi} \frac{\pi R^2 I_o \sin \theta}{r^3} \exp(-jkr)$$

$$E_\phi = \frac{Z_o k}{4\pi} \frac{\pi R^2 I_o \sin \theta}{r^2} \exp(-jkr)$$

Characteristic
Impedance

$$Z_w = \left| \frac{E_\phi}{H_\theta} \right| = Z_o k r$$



2. Electromagnetic field of magnetic dipole

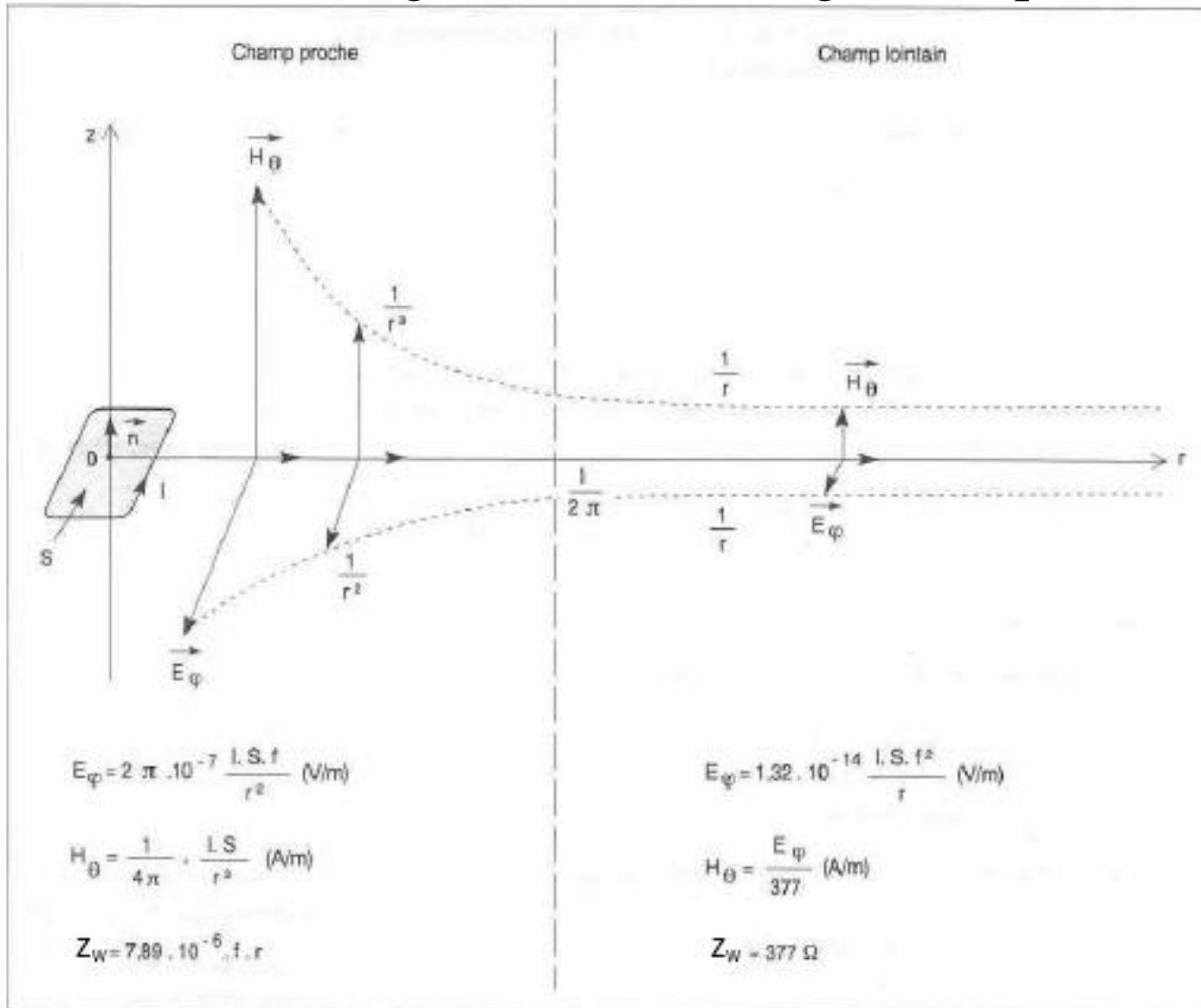



D. Radiated Coupling

Wave impedance of electromagnetic field

E/H is called **wave impedance**. It is an important parameter as it determines the coupling efficiency of this wave with a structure, and the efficiency of a shielding structure.

In far-field ($r \gg \lambda/2\pi$), plane wave, E and H are decreasing in the same proportion with distance.

Z is a constant and in air 377Ω .

In near-field ($r \ll \lambda/2\pi$), Z is determined by the characteristics of the source.

D. Radiated Coupling

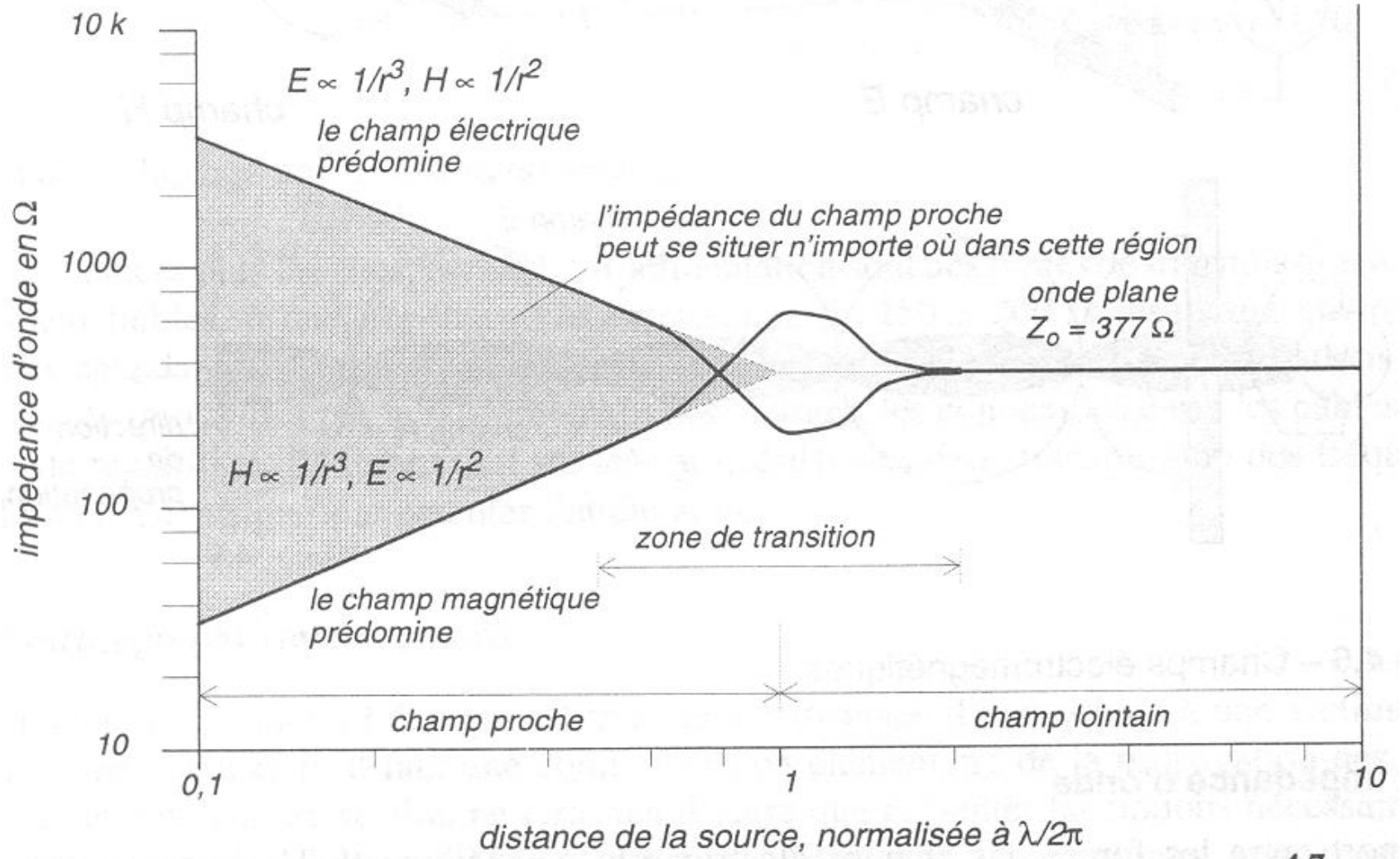

4.7



D. Radiated Coupling

Far-field – near-field

Rayleigh criterion

This criterion is related to the radiating diagram of an antenna, too large to be considered as a punctual source.

To consider a far-field condition as acceptable, it is needed that the phase shift of the components of the radiated field from the 2 ends of the antenna is small, regarding λ .

We have a criterion related to λ and maximum dimension D of antenna:

$$d \gg \gg 2D^2/\lambda$$



Disturbances

Véronique Beauvois, Ir.
2021-2022



An electromagnetic phenomenon susceptible to degrade the performances of an apparatus or system.

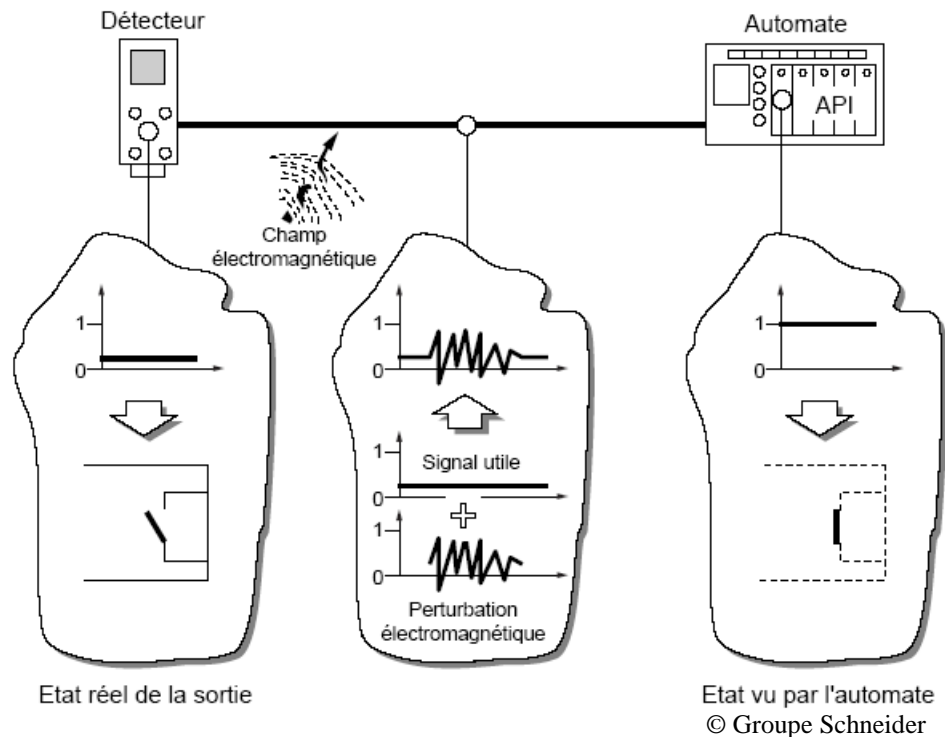



- frequency: L.F. / H.F.
- conducted / radiated
- narrowband / broadband
- duration (t): permanent, repetitive, transient, random
- common mode/differential mode

Types of disturbances - Classification



Frequency: L.F. H.F.

- $0 \leq f \leq \dots 1$ MHz
- conducted

- $f > 30$ MHz
- radiated

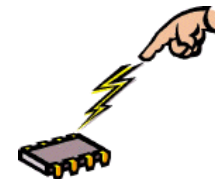
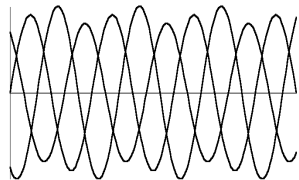
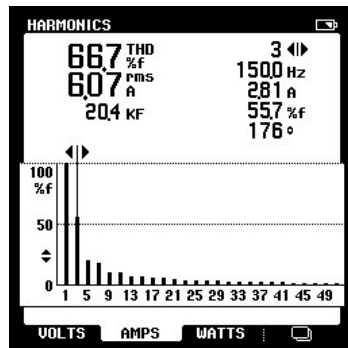
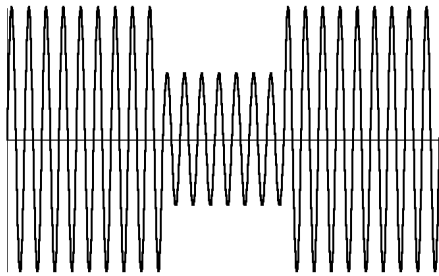

Types of disturbances - Classification



Conducted
Voltage/current

Radiated
Electric/Magnetic fields

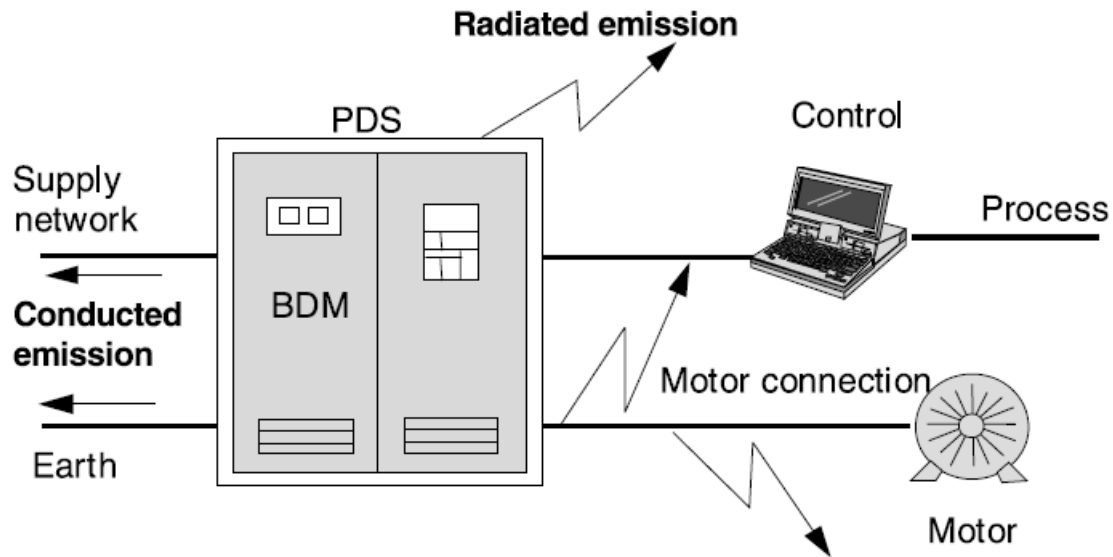



Narrowband (disturbance bandwidth < receiver's one)

Broadband (disturbance bandwidth > receiver's one)

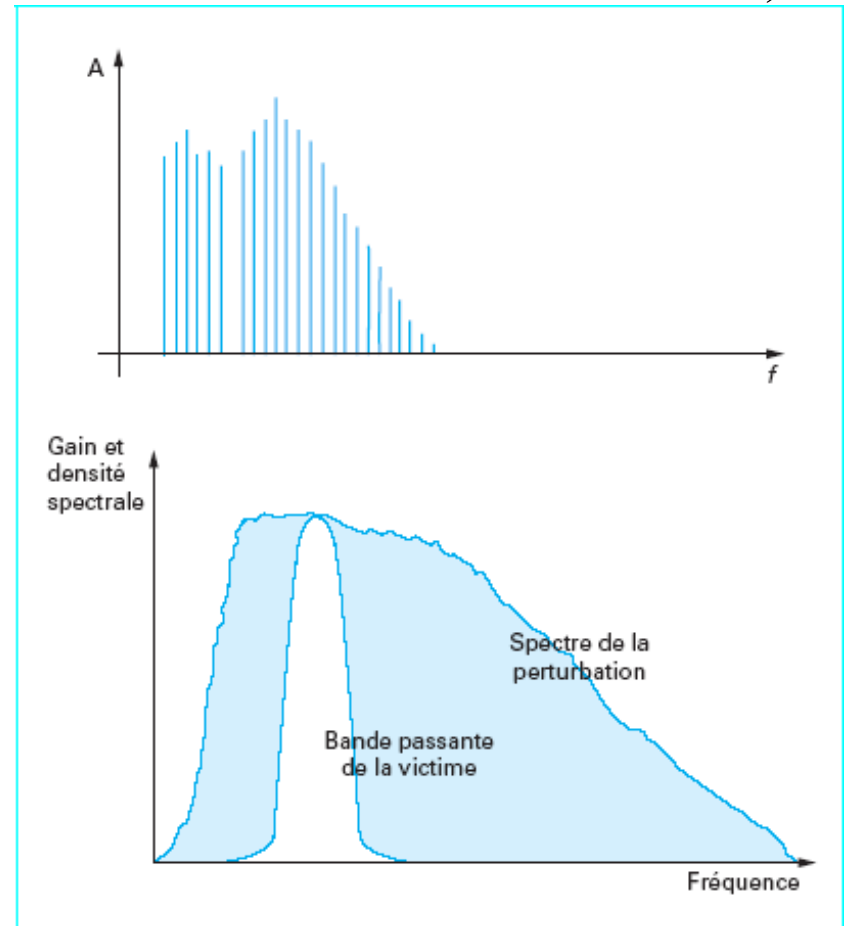
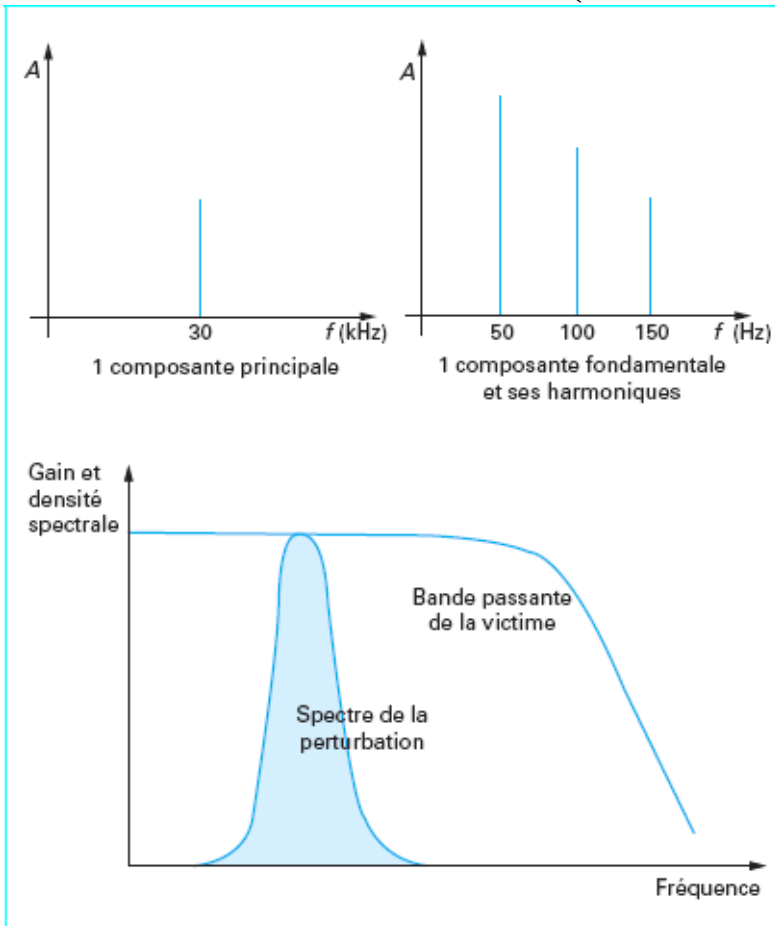



Common Mode – Differential Mode

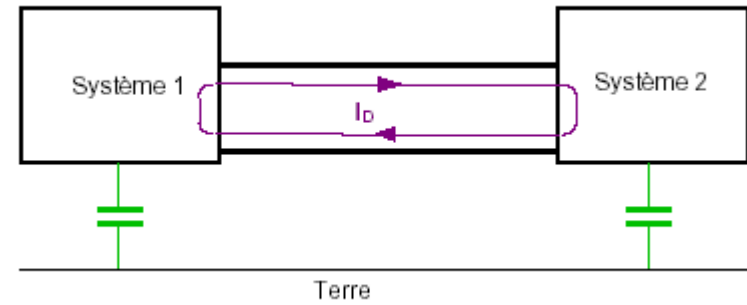
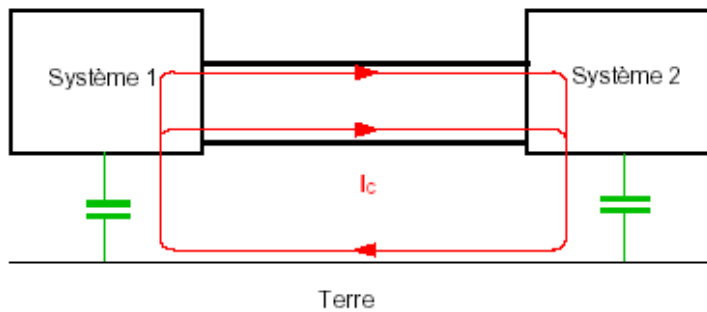



- L.F. / conducted

continuous:

- quick variation of voltage (**flicker**)
- (frequency variation)
- harmonics
- (interharmonics)

transient:

- voltage variations
- dips and interruptions
- slow overvoltages
- lightning



Power-line flicker is a visible change in brightness of a lamp due to rapid fluctuations in the voltage of the power supply. The voltage drop is generated over the source impedance of the grid by the changing load current of an equipment (frequent starting of an elevator motor, air conditioning systems, arc furnaces, welding machines, ...).

Effects in the band 0.5-25Hz.

Major consequences on lamps.

Standards

IEC/EN 61000-3-3 ($I < 16\text{A}$)

IEC/EN 61000-3-11 ($16\text{A} < I < 75\text{A}$)

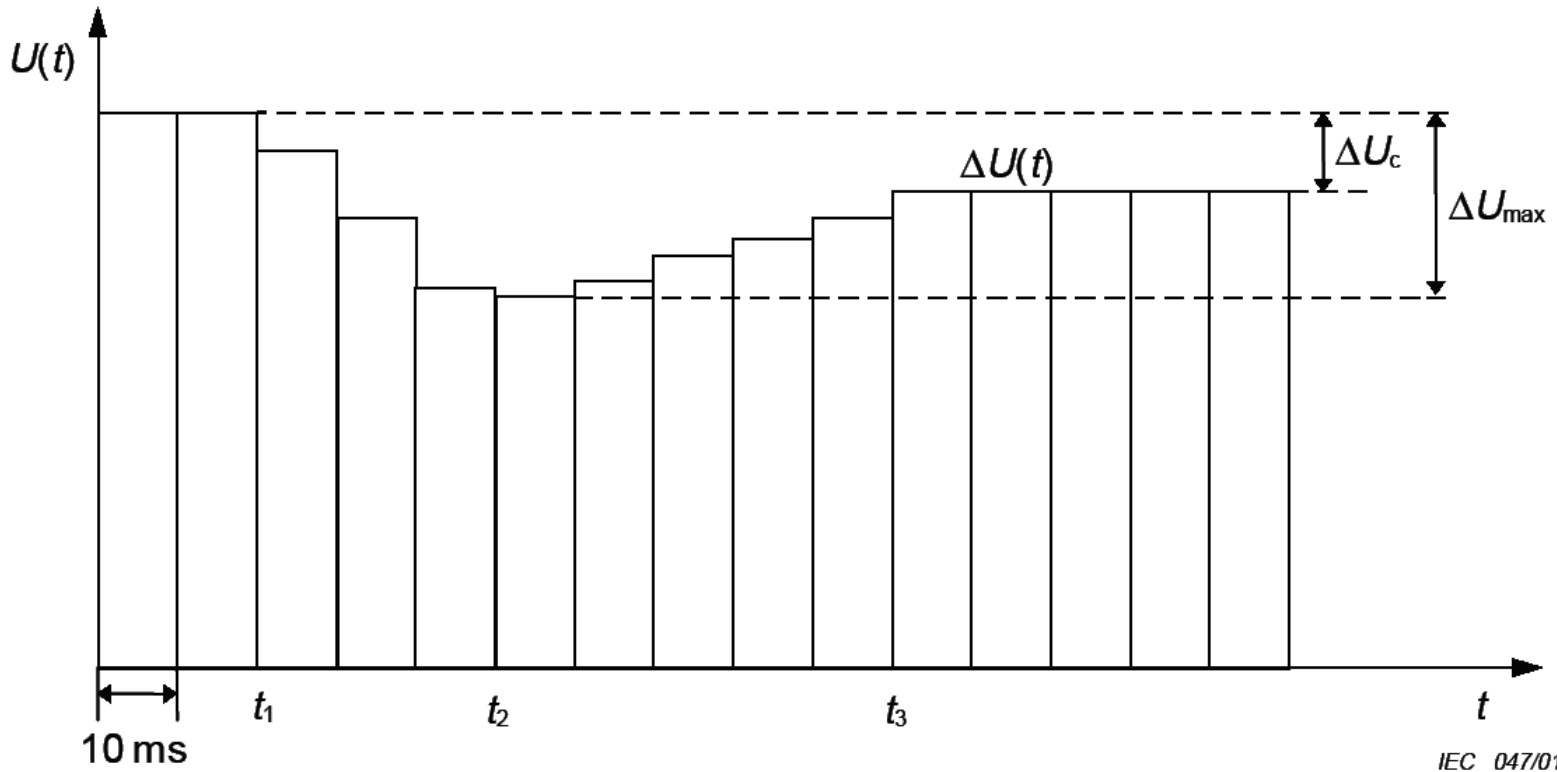

IEC 047/01

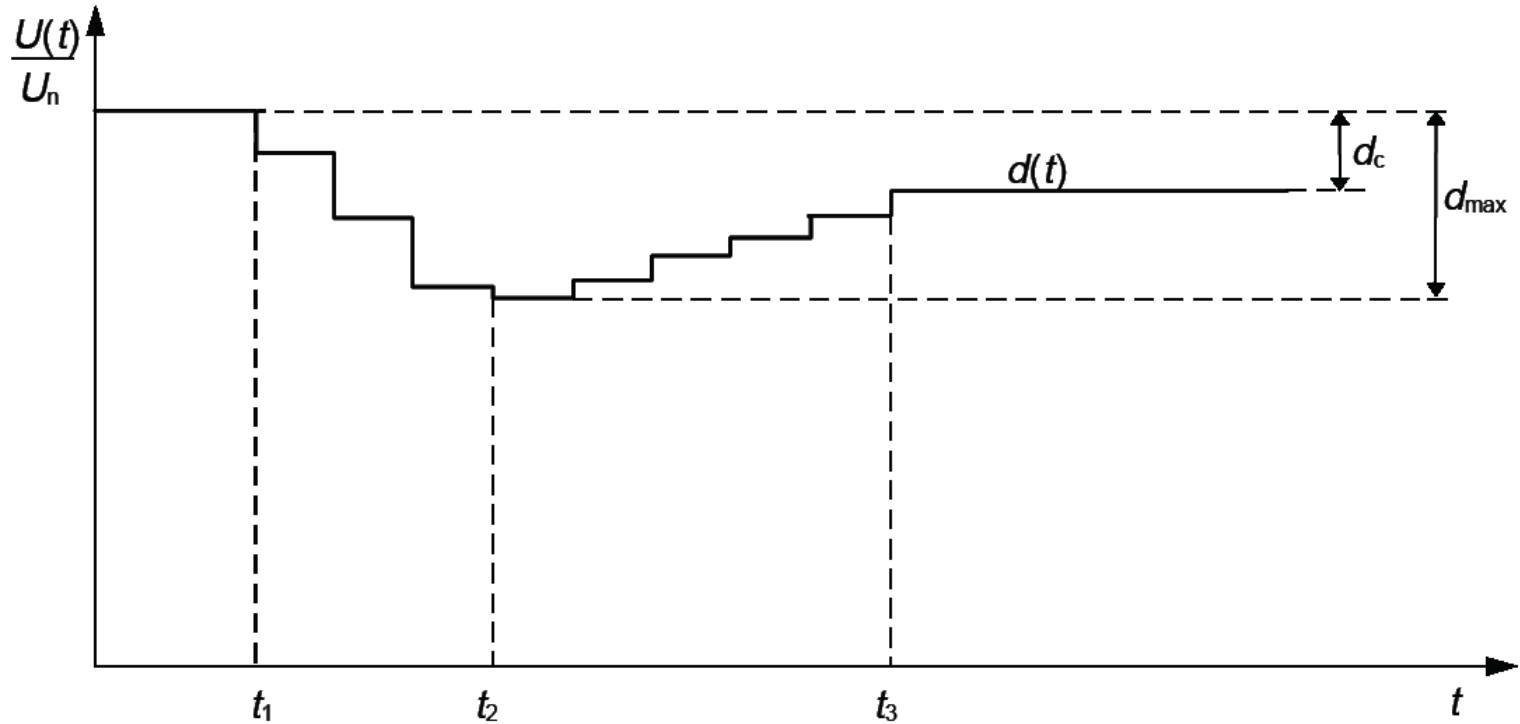

IEC 048/01

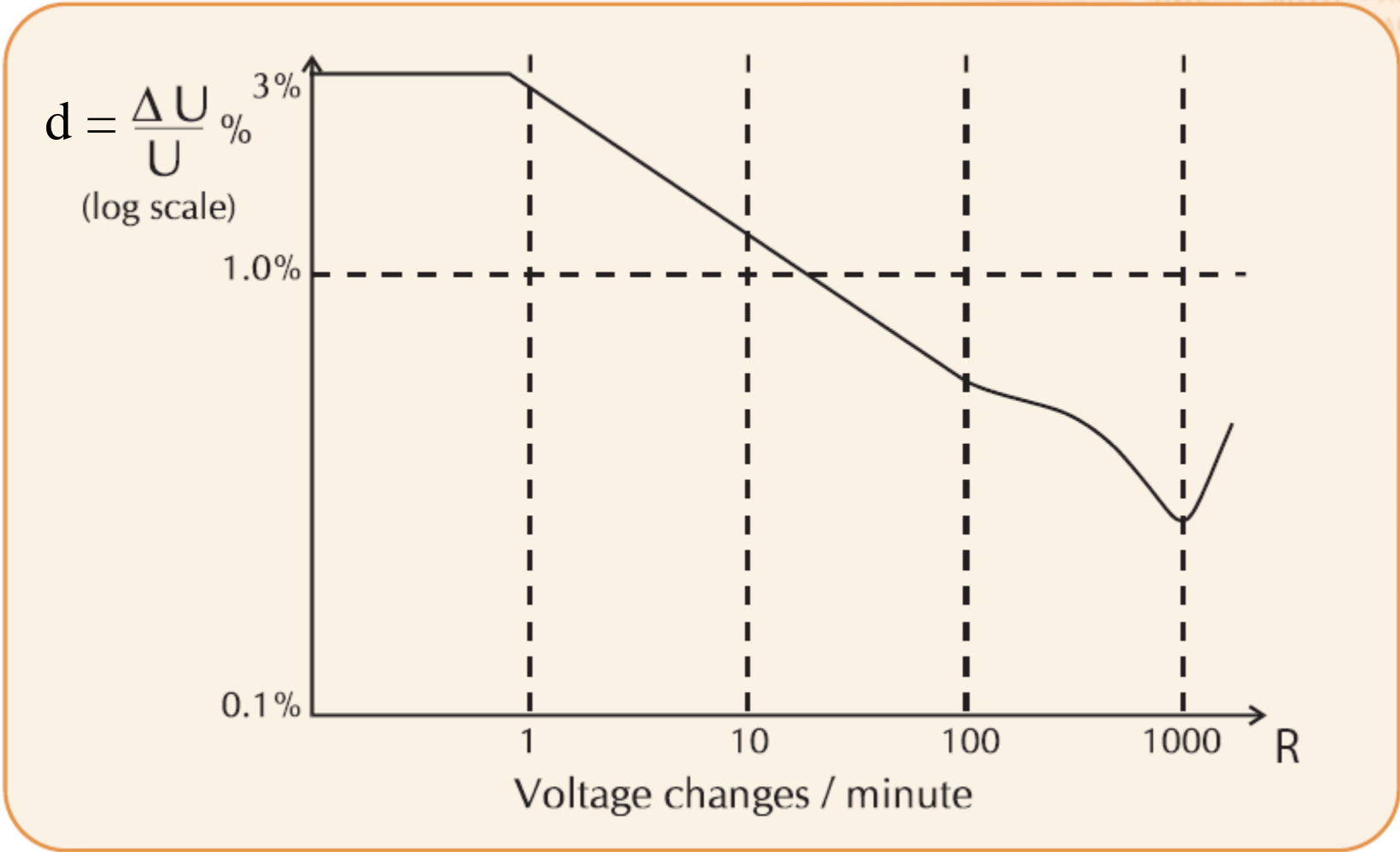



- L.F. / conducted

continuous:

- quick variation of voltage (flicker)
- (frequency variation)
- harmonics
- (interharmonics)

*Rare with the
network meshing*

The origin of the phenomenon is related to the production of electric energy by a generating set with a not well regulated frequency, especially if the load changes frequently.

Electronic equipment shall support a frequency variations of +/- 4% measured during 10 minutes.

As the European grid is well meshed, its power is almost infinite, and frequency error is around 0.1%.



- L.F. / conducted

continuous:

- quick variation of voltage (flicker)
- (frequency variations)
- harmonics
- (interharmonics)

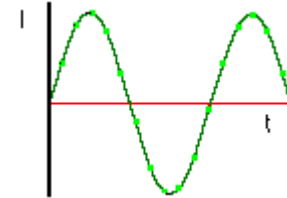
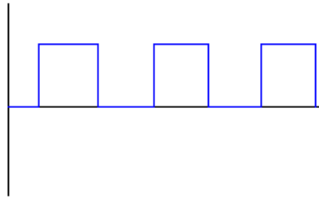

We have seen that a **periodic signal** could be represented by a sum of **sinus** with different amplitudes and phases, with **frequency multiple integer of fundamental** (frequency f).

Harmonics.

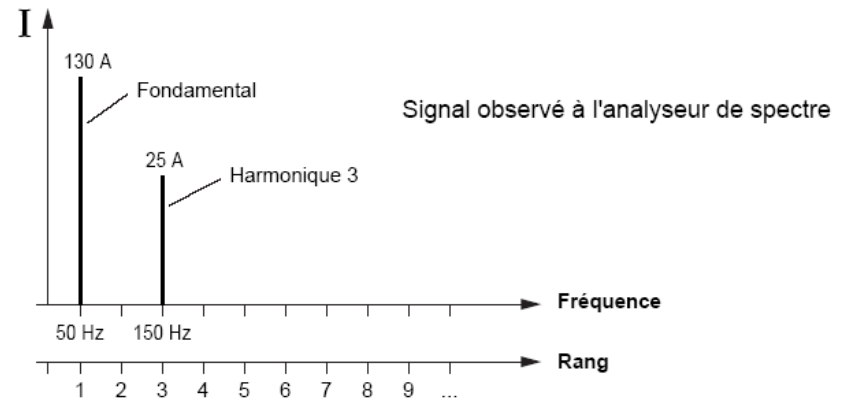
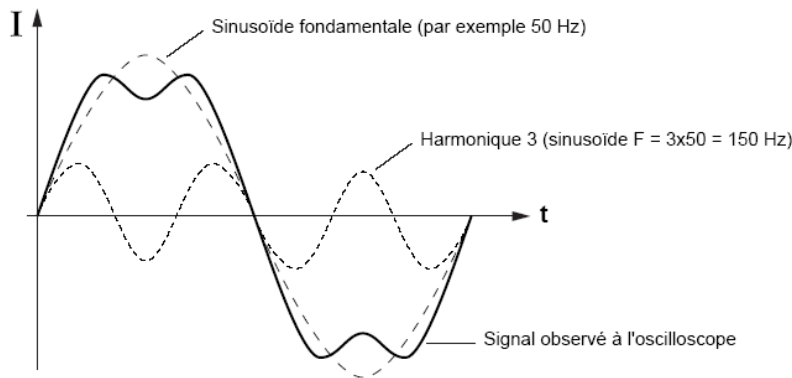



Origin?

All non linear loads are associated with a non sinusoidal current and generates harmonics

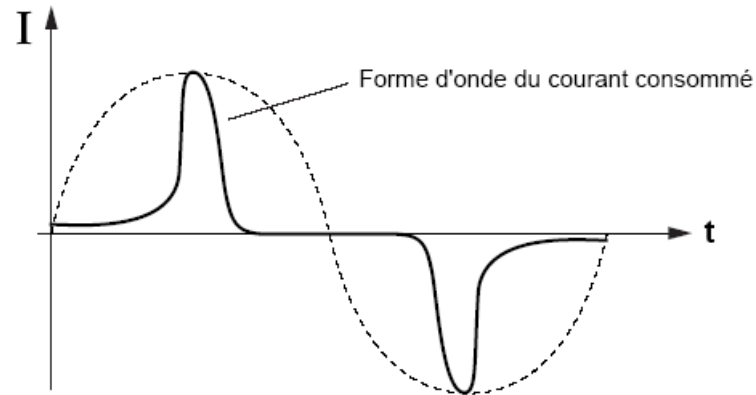

Courant consommé par un tube fluorescent



Sources?

All non linear loads

- inverters, choppers, dc-dc converters
 - rectifiers
 - speed controllers
- frequency converters
 - dimmers
 - lighting
- Induction heating systems
- Saturated magnetic circuits
 - ...



Consequences?

Heating

Losses

Saturation

Additional torque components

Resonance (Q compensation capacitors)

Homopolar components (H3)

...



- L.F. / conducted

continuous:

- quick variation of voltage (flicker)
- (frequency variation)
- harmonics
- (interharmonics)

Non integer multiples of the mains frequency.

Sources: static frequency converters for low speed applications, cycloconverters, ... (e.g. cement crushers).

Harmonics $K.fr \pm k.fo$ (fr mains frequency and fo output frequency).



- L.F. / conducted transient:
 - voltage variations
 - dips and short interruptions
 - slow overvoltages
 - sinusoidal damped overvoltages
 - burst, lightning

Voltage variations: +6 to -10% with load variations (e.g. starting of powerful motors, arc furnaces, ...).

Dips: consequence of a network problem as a short-circuit. Parameters: voltage reduction in % of U_n and duration (ms).

Short interruptions: interruptions with a duration less than 10 ms (half period).



- L.F. / conducted
 - transient:
 - voltage variations
 - dips and short interruptions
 - slow overvoltages
 - sinusoidal damped overvoltages
 - burst, lightning

Slow overvoltages: overvoltages due to capacitors banks start up (Q reactive power compensation) or a fuse fusion.

Sinusoidal damped overvoltages: some maneuvers on the medium voltage network as an opening or closing of breakers, switches, disconnecting switches, ... may cause a voltage variation which excites the line with a very short pulse with a short rise time and the consequence is a damped sinus (frequency between 10 kHz and 1 MHz).



- en L.F. / conducted
 - transient:
 - voltage variations
 - dips and short interruptions
 - slow overvoltages
 - sinusoidal damped overvoltages
 - burst, lightning

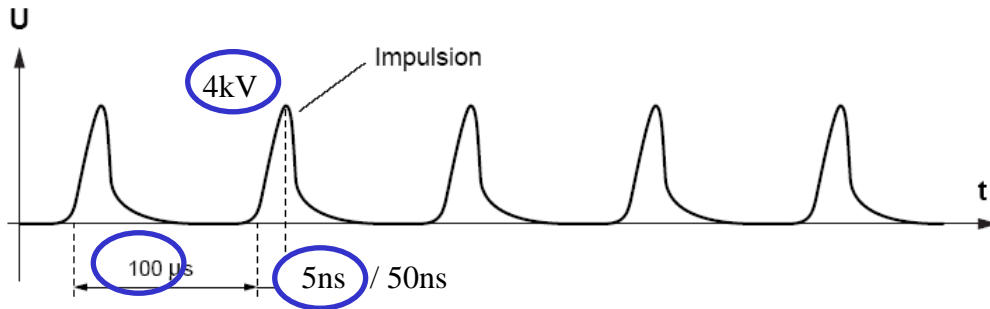

La période de répétition dépend du niveau de la tension d'essai

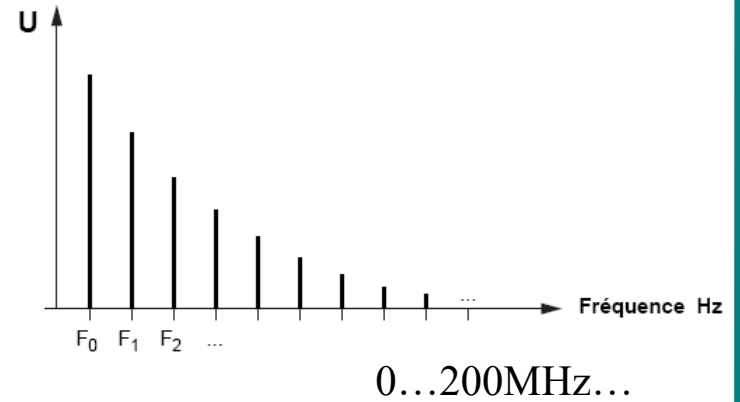
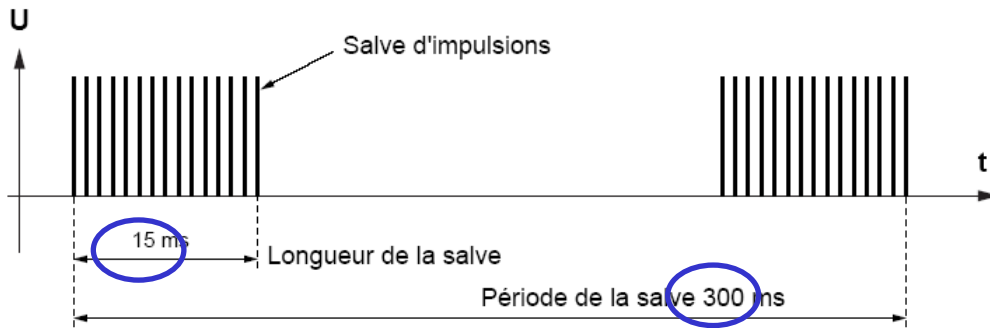

Transient - Lightning



Lightning is a powerful sudden flow of electricity that occurs during an electric storm. The discharge will travel between the electrically charged regions within a thundercloud, or between a cloud and a cloud, or between a cloud and the surface of the planet. The charged regions within the atmosphere temporarily equalize themselves through a lightning flash, commonly referred to as a strike if it hits an object on the ground.

There are three primary types of lightning: from a cloud to itself (intra-cloud), from one cloud to another cloud and between a cloud and the ground.

Parameters: distance, current value, discharge shape.



Direct lightning

If lightning current flows directly in the electrical circuit, creating voltages (according impedance of the circuits).

Consequences: insulation disruption (voltage), thermal destruction (current).

Not disturbances but destructive phenomena (dangerous for materials and human beings).

Protection: lightning arresters, shielding, overhead ground wires (the aim is to connect surge current to ground).



Indirect phenomena

Even with protections to direct phenomena, some currents are flowing in electrical circuits > overvoltages (parameters: distance, di/dt , geometry of circuits)

Discharge shape

Unidirectional pulse, with very short rise time for negative discharges (10 to 20 μ s for the first, less than 1 μ s for the following ones) and a bit longer for positive discharges (around 20 - 50 μ s). Duration 10² μ s for negative discharges and 1000 to 2000 μ s for positive discharges.

Surge current: +/- 30kA for first arcing and 12kA for the followers.

Induced phenomena: variable amplitude & shapes according to coupling modes, protection elements, capacitors, varistors, surge arrestors.

Transient - Lightning



Normalized waveshape

Voltage 1,2/50 μ s

Current 8/20 μ s

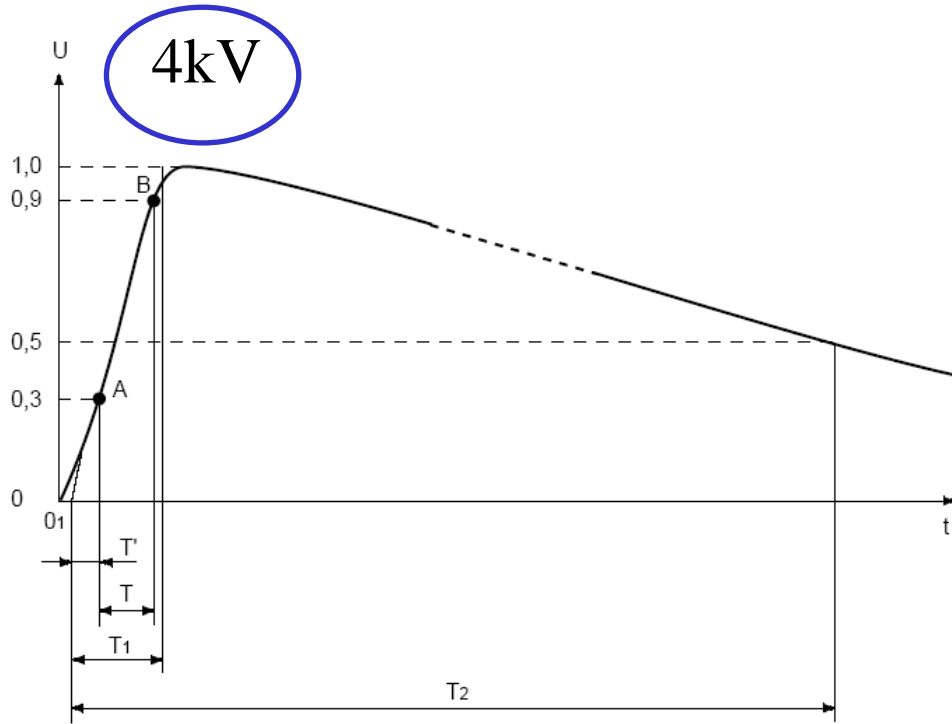

4kV

$T_1 = 1,67 T$
 $T' = 0,3 T_1 = 0,5 T$

$T_1 = 1,2 \mu s$ $T_2 = 50 \mu s$

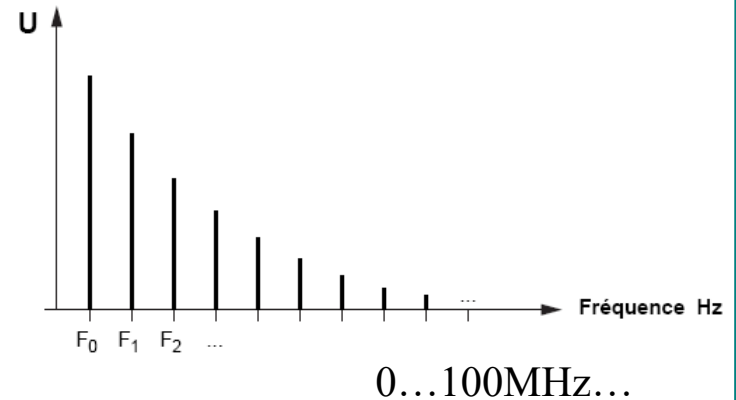



- **H.F. / conducted**

continuous

- Common mode current of static converters
- Power line communications

transient

- inductive circuits commutation
- lightning
- **electrostatic discharges**

Electrostatic Discharges

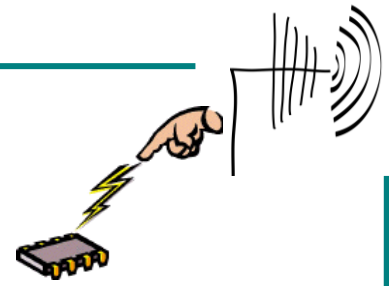

Origin?

Static electricity

Electricity comes from *elektron* which means *amber*, which charge by friction.

In nature: atoms = electrons + protons + neutrons = electrically neutrals.

When you rub certain materials together, superficial electrons are pull out (e.g. silk on a glass tube, a balloon on your hair).

Accumulation of charges by *triboelectricity*.

Static electricity: the charges could not move, they are trapped in the insulating materials.

- Positive effects: some industrial applications as painting deposits on a material
- Negative effects: Hindenburg dirigible (1937).

Electrostatic Discharges

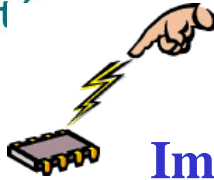

Important parameters?

- nature of the material (triboelectric series)
- relative humidity
- temperature

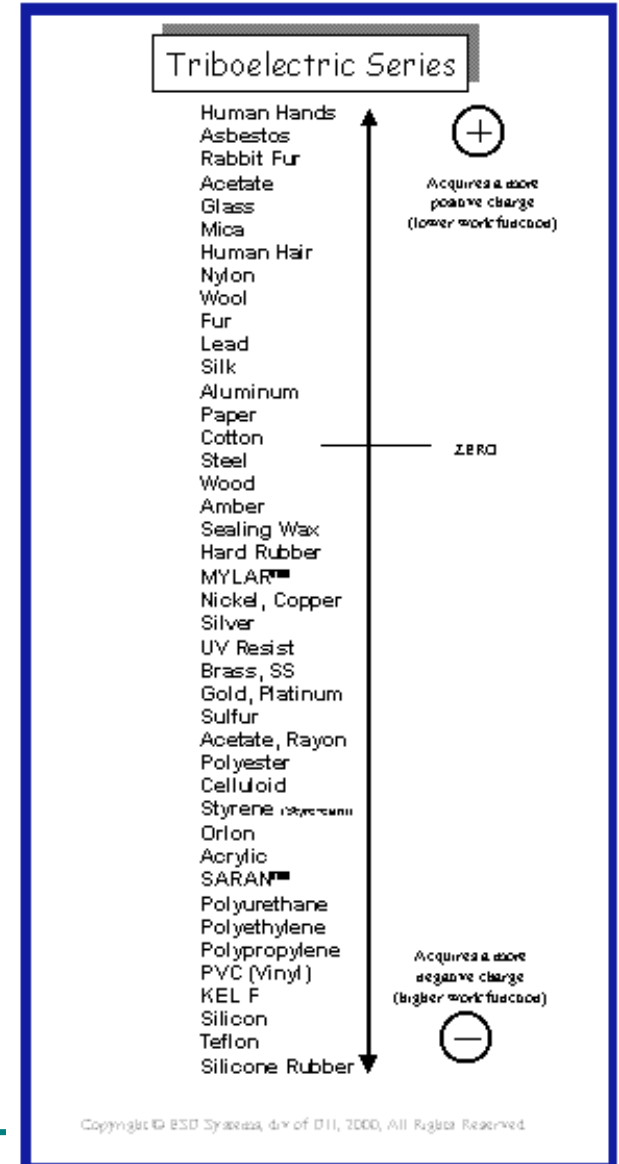
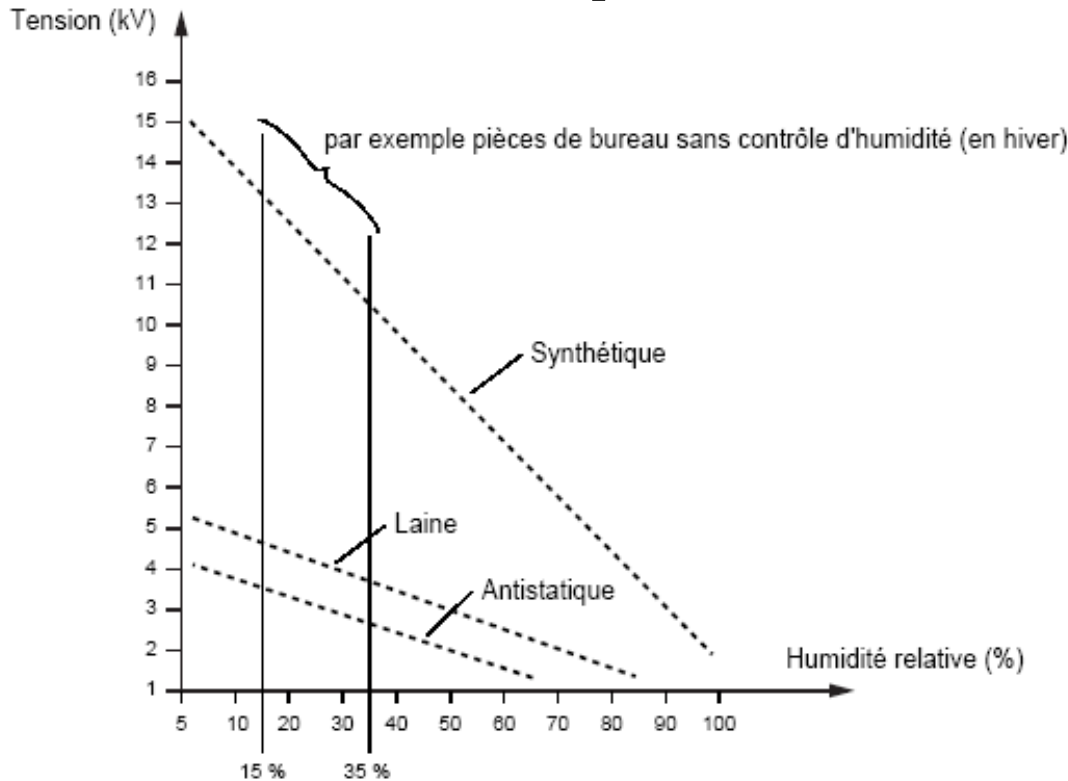

Electrostatic Discharges

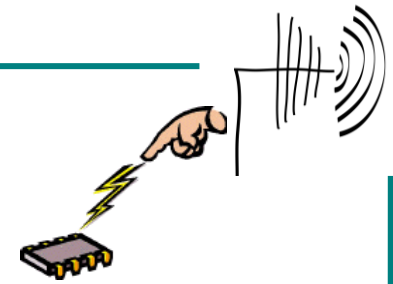

Current pulse through an object, with a (direct or indirect) contact of this object to the ground, with another object at a high level electrical potential regarding the ground.

